

Operating instructions

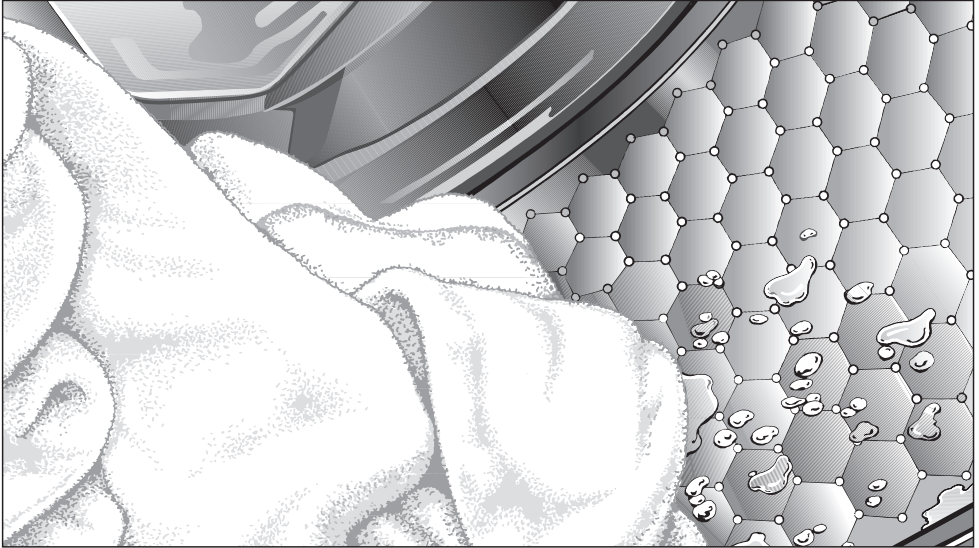

for Washing machine W 5922

To avoid the risk of accidents or damage to the machine it is **essential** to read these instructions before it is installed and used for the first time.

en - GB, IN

M.-Nr. 09 011 590

Caring for our environment

Disposal of the packing material

The transport and protective packing has been selected from materials which are environmentally friendly for disposal and should be recycled.



Ensure that any plastic wrappings, bags etc. are disposed of safely and kept out of the reach of babies and young children. Danger of suffocation!

Disposal of your old machine

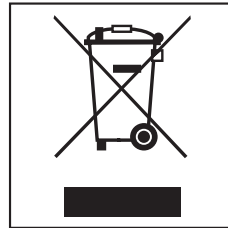
Electrical and electronic machines often contain materials which, if handled or disposed of incorrectly, could be potentially hazardous to human health and to the environment. They are, however, essential for the correct functioning of your machine. Please do not therefore dispose of it with your household waste.



Please dispose of it at your local community waste collection / recycling centre or contact your Dealer for advice. Ensure that it presents no danger to children while being stored for disposal.

Caring for our environment	2
Warning and Safety instructions	6
Operating the washing machine	10
Control panel	10
Display	11
Before using for the first time	13
Washing environmentally and economically	15
How to wash correctly	16
Extra options	23
Short	23
Water plus	23
Stains 	23
Extra quiet	23
Further extras 	24
Extra rinse	24
Pre-wash	24
Soak	24
Rinse hold	24
The following extra options can be selected in addition to the programme:	25
Spinning	26
Final spin speed	26
Rinse and interim spin	26
To omit the final spin (Rinse hold)	26
To omit rinse and interim spin and the final spin (No spin)	26
Delay start	27
Programme chart	28
Programme sequence	32
Garment care label symbols	34
Changing the programme sequence	35
Cancelling a programme	35
Interrupting a programme	35
Changing a programme	35
Adding or removing laundry after a programme has started	36
Safety lock	36

Contents

Detergent	37
The correct detergent	37
Water softeners	40
Washing with several components	40
Fabric conditioners and liquid starch	41
Automatic dispensing of fabric conditioner or liquid starch to laundry at the end of a programme	41
Adding fabric conditioner or starch separately	41
Colour run and dye removers/dyes	41
Cleaning and care	42
Cleaning the drum (Hygiene info)	42
External casing and fascia panel	42
Cleaning the detergent dispenser drawer	42
Cleaning the water inlet filters	44
Problem solving guide	45
The programme does not start	45
One of the following fault messages appears in the display	46
The following fault messages appear in the display at the end of the programme	47
Problems with the load size indicator or calibrating to zero	48
General problems	49
An unsatisfactory wash result	50
The door will not open	51
Opening the drum door in the event of a blocked drain outlet and/or power failure	52
Blocked drain outlet	52
After sales service	54
Future updates (PC)	54
Appliance guarantee	54
Optional spare parts and accessories	54
Installation and connection	55
Front view	55
Rear view	56
Installation surface	57
Transporting the washing machine to its installation site	57
Removing the transit bars	57
Re-fitting the transit bars	59

Levelling the machine	60
Screwing out and adjusting the feet	60
Building under a continuous worktop/in a kitchen run	61
Washer and Dryer stack	61
The Miele water protection system	62
Connection to the water supply	63
Connection to the drainage system	64
Electrical connection U.K.	65
Consumption data	66
Notes for test institutes:	66
Technical data	67
Settings menu	68
To open the Settings menu	68
To select a setting	68
To close the Settings menu	68
Language 	68
Time	68
Gentle action	69
Longer pre-wash Cottons	69
Suds cooling	69
Lock code	70
Temperature unit	71
Buzzer	71
Keypad tone	71
Brightness	71
Contrast	71
Standby display	72
Memory	72
Anti-crease	72
Optional accessories	73
CareCollection	73

Warning and Safety instructions

This washing machine conforms to current safety requirements. Inappropriate use can, however, lead to personal injury and damage to property.

To avoid the risk of accidents and damage to the washing machine, please read these instructions carefully before using it for the first time. They contain important information on its installation, safety, use and maintenance.

Keep these instructions in a safe place and ensure that new users are familiar with the content. Pass them on to any future owner.

Correct application

► This washing machine is not designed for commercial use. It is intended for use in domestic households and in similar working and residential environments such as:

- Shops
 - Offices and showrooms
- and by residents in establishments such as

- Hostels and guest houses

► This washing machine is not intended for outdoor use.

► It must only be used as a domestic appliance to wash items which are specified by the manufacturer as being washable on the care label. Any other usage is not supported by the manufacturer and could be dangerous. Miele cannot be held liable for damage resulting from incorrect or improper use or operation of the washing machine.

► This washing machine is not intended for use by people with reduced physical, sensory or mental capabilities, or lack of experience and knowledge, unless they are supervised whilst using it or have been shown how to use it by a person responsible for their safety.

Safety with children

► Keep children away from the washing machine at all times. It is not a toy! To avoid the risk of injury do not allow children to play on or near it or to play with its controls. Supervise children whilst you are using it.

► Older children may only use the washing machine if its operation has been clearly explained to them and they are able to use it safely, recognising the dangers of misuse.

► For machines with a 'porthole' door, remember that the porthole glass will be hot when washing at very high temperatures.
Do not let children touch it.

Warning and Safety instructions

Technical safety

► Before setting up the washing machine, check it for any externally visible damage.

Do not install or use a damaged washing machine.

► Before connecting the washing machine, ensure that the connection data on the data plate (voltage and connected load) match the mains electricity supply. If in any doubt, consult a qualified electrician.

► The electrical safety of this washing machine can only be guaranteed when continuity is complete between it and an effective earthing system which complies with current local and national safety regulations. It is most important that this basic safety requirement is present and regularly tested, and where there is any doubt the household wiring system should be inspected by a qualified electrician. The manufacturer cannot be held liable for the consequences of an inadequate earthing system (e.g. electric shock).

► Do not connect the washing machine to the mains electricity supply by an extension lead. Extension leads do not guarantee the required safety of the appliance (e.g. danger of overheating).

► Faulty components must only be replaced by genuine Miele original spare parts. Only when these parts are fitted can the safety standards of the machine be guaranteed.

► Unauthorised repairs could result in unforeseen dangers for the user, for which Miele cannot accept liability. Repairs should only be undertaken by a Miele approved service technician. Ensure current is not supplied to the machine until after maintenance or repair work has been carried out.

► If the connection cable is faulty it must only be replaced by a Miele approved service technician to protect the user from danger.

► In the event of a fault or for cleaning purposes, the washing machine is only completely isolated from the electricity supply when:

- it is switched off at the wall socket and the plug is withdrawn, or
- it is switched off at the mains, or
- the mains fuse is withdrawn, or the screw-out fuse is removed (in countries where this is applicable).

► This washing machine must only be connected to the on-site water supply using a new hose kit. Old hoses must not be re-used.

► In countries where there are areas which may be subject to infestation by cockroaches or other vermin, pay particular attention to keeping the machine and its surroundings in a clean condition at all times. Any damage which may be caused by cockroaches or other vermin will not be covered by the guarantee.

Warning and Safety instructions

- ▶ This appliance must not be used in a non-stationary location (e.g. on a ship).
- ▶ Do not make any alterations to the washing machine, unless authorised to do so by Miele.

Correct use

- ▶ Do not install your washing machine in rooms where temperatures below freezing may occur. Frozen hoses may burst or split. The reliability of the electronic control unit may be impaired at temperatures below freezing point.
- ▶ Before using the washing machine for the first time, check that the transit bars at the rear of the machine have been removed (see section on "Installation and connection"). During spinning, a transit bar which is still in place may result in damage to both the machine and adjacent furniture or appliances.

- ▶ Turn off the stopcock if the machine is to be left for any length of time (e.g. holiday), especially if there is no floor drain (gully) in the immediate vicinity.
- ▶ Flooding danger.
If hooking the drain hose into a wash basin, check that the water can drain off quickly enough to prevent the sink from overflowing. Make sure the drain hose is secure, so that the force of the water flowing out of the hose does not dislodge it.
- ▶ Take care to ensure that foreign objects (e.g. nails, pins, coins, paper clips) do not find their way into the machine with the laundry. These may damage components of the machine (e.g. suds container, drum), which in turn can result in damage to the laundry.

Warning and Safety instructions

- ▶ If the correct amount of detergent is dispensed, the machine should not need to be descaled. If, however, you do wish to descale the machine only use proprietary non-corrosive descaling agents and strictly observe the instructions on the packaging. A special descaling agent is available to order from the Miele Spare Parts Department or via the internet on www.miele-shop.com.
- ▶ Textiles which have been pre-treated with solvent based cleaning agents must be thoroughly rinsed in clean water before being washed in the machine.
- ▶ Never use solvent based cleaning agents, e.g. those containing benzene, in this machine, as this may result in damage to component parts and create toxic fumes. Such agents also pose a fire and explosion hazard.
- ▶ Never use solvent based cleaning agents, e.g. those containing benzene, to clean the outside surfaces of this machine. They can cause damage to plastic surfaces.
- ▶ Only use dyes specified by the manufacturer as being suitable for use in a domestic washing machine. Always observe the manufacturer's instructions carefully.
- ▶ Colour run and dye removers contain sulphur compounds which can cause damage such as corrosion. Do not use these products in this machine.
- ▶ If detergent comes into contact with the eyes, rinse them thoroughly with lukewarm water immediately. If swallowed, seek medical assistance immediately and retain the packaging or label for reference. Those with skin problems or sensitive skin should avoid their skin coming into contact with detergent.
- ▶ Only remove laundry from the washing machine once the drum has stopped turning. Reaching into a moving drum is extremely dangerous and could result in injury.

Accessories

- ▶ Accessory parts may only be fitted when expressly approved by Miele. If other parts are used, guarantee, performance and product liability claims will be invalidated.

Miele cannot be held liable for damage caused by non-compliance with these Warning and Safety instructions.

Operating the washing machine

Control panel

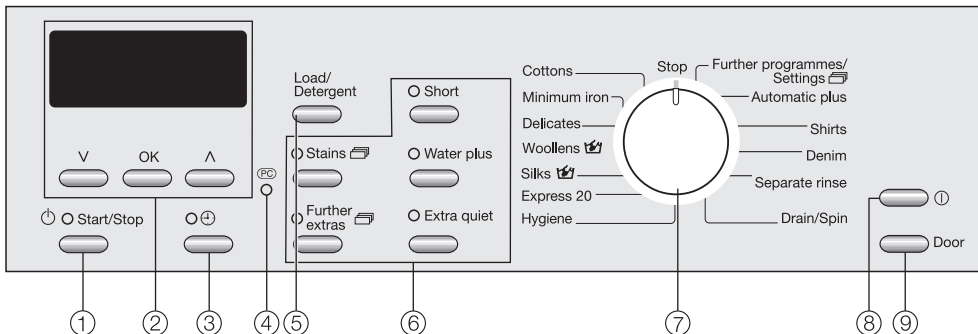

① **Start/Stop button**

For starting the programme selected and cancelling a programme once it has started.

② **Display with V, OK and ^ buttons**

See the following page for more information.

③ **+/- button**

For selecting delay start.

④ **PC/Optical interface**

This is used by service technicians to run diagnostic checks on your machine and can also be used to update programming data in the future.

⑤ **Load/Detergent button**

For calling up the load size or the recommended amount of detergent, and for calibrating the load size sensor to zero.

⑥ **Extra option buttons** with indicator lights

Various extra options can be added to the washing programmes.

⑦ **Programme selector**

For selecting a programme. The programme selector can be turned clockwise or anti-clockwise.

⑧ **I button**

For switching the washing machine on and off.
To save energy, the washing machine will switch itself off automatically 15 minutes after the end of the programme/anti-crease phase or after being switched on if no other selection is made.

⑨ **Door button**

Opens the machine door.

Operating the washing machine

Display



The display is operated using the **V**, **OK** and **^** buttons.

- Press the **V** button to move down to the next text or to decrease the value highlighted in the display.
- Press the **^** button to move up to the next text or to increase the value highlighted in the display.
- Press the **OK** button to confirm the value highlighted in the display.

Programme selection examples

To decrease or increase a value



Press the **V** button to decrease the temperature and the **^** button to increase the temperature.

Multiple option selection

If a value is selected, there will be a tick next to it.

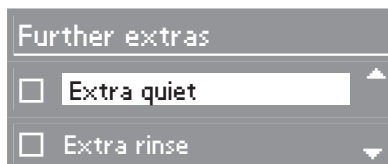

Press the **V** or **^** button to scroll down or up the options in the display. Press the **OK** button to select the highlighted value. You can now select the next value, if you wish.

Single option selection

Here one of the values is always selected. A tick will appear next to the one currently selected. The other values are deselected automatically.



Press the **V** or **^** button to scroll down or up the options in the display. Press the **OK** button to select the highlighted value.

To come out of a sub-menu

Select *Back*  to come out of the sub-menu or wait for approx. 15 seconds and the display will return to the programme menu automatically.

Operating the washing machine

The following are selected via the display

- wash temperature
- final spin speed
- the soak time
- delay start
- cancellation of a programme
- safety lock

The following are selected via *Further programmes/Settings*

- Dark garments
- Sportswear
- Trainers
- Outerwear
- Proofing
- Soft toys
- First wash
- Pillows
- Curtains
- Starch

Before using for the first time

Before using the machine for the first time ensure that it is correctly installed and connected. See "Installation and connection". Also check that the drain filter is securely tightened to prevent the risk of water leaks during use.

This washing machine has undergone a complete functional test at the factory and there will be some residual water in the drum from this process.

The washing machine has a sensor which measures the amount of laundry in the drum. This determines the amount of detergent required. To allow the load size indicator to function correctly, you must first run a wash programme without any laundry and without detergent.

- Press the **⓪** button in.

If the washing machine is being switched on for the first time, the welcome screen will appear briefly.

The welcome screen will appear in the display every time the machine is switched on until a programme lasting longer than 1 hour has been completed.

The display for setting the language will then appear.

Setting the language

You will be asked to select the language you require for the display. It is possible to select another language at any time via *Further programmes/Settings*  in the *Settings* sub-menu.



- Press the **∨** and **∧** buttons to scroll through the options until the language that you want is highlighted. Press the **OK** button to confirm your selection.

Setting the time (of day) (if necessary)

The display for setting the time will then appear.

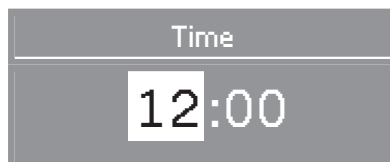

- Press the **∨** button to decrease or the **∧** button to increase the hour.
- Confirm the hour selected with the **OK** button. Then do the same to set the minutes.

Before using for the first time

Reminder to remove transport bars

 To avoid the risk of damage, the transport bars must be removed before the machine is used for the first time. See "Installation and connection" for instructions on how to do this.

- After removing the transport bars (if this has not already been done by your fitter) press the **OK** button.

Running your first programme

Your machine is now ready for the first programme to be run.

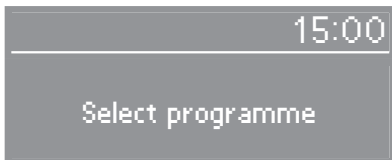

- Turn the programme selector to *Cottons*.
- Open the stopcock.
- Press the *Start/Stop* button.
- At the end of the programme switch the machine off.

After running the first programme, the load sensor has to be calibrated to zero as you would with bathroom scales.

Calibrating the load sensor to zero

- Switch on the washing machine.
- Open the drum door.
- Turn the programme selector to *Cottons*.

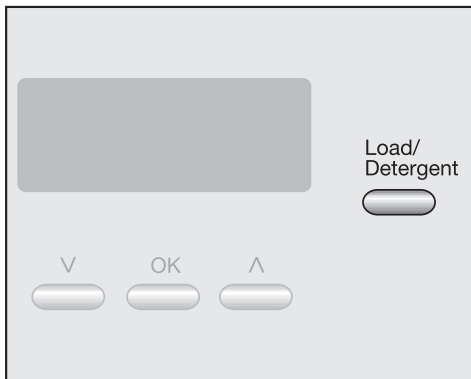

- Press and hold the *Load/Detergent* button pressed in until the following message appears in the display:

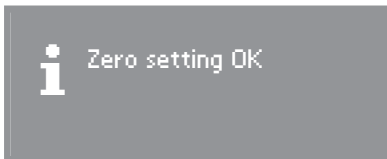

- Switch off the washing machine.

The washing machine is now ready for use.

Washing environmentally and economically

Energy and water consumption

- Water consumption and energy usage are determined by the size of the load.
To make the most out of your machine, load the maximum dry load for the programme you are using.
- When smaller amounts of laundry are washed, the automatic load recognition system will reduce the amount of water, time and energy used. This may mean that the time left shown in the display is adjusted during the course of the wash programme.
- Use the *Express 20* programme for small loads.
- Modern detergents make it possible to wash at lower temperatures (e.g. 20°C). Washing using lower temperature settings will save energy.
- To maintain the hygiene of the washing machine, carry out a hot wash (60°C or above) using powder detergent at regular intervals. The **Hygiene Info** message will appear in the display to remind you to carry out a hot wash.

Detergent

- Do not exceed the amounts of detergent recommended by the manufacturer on the packaging.
- Adjust the dosage to the degree of soiling of the laundry.
- Reduce the amount of detergent for smaller loads. Use the *Load/Detergent* button.

Choosing the correct Extra option (Short, Soak, Pre-wash)

Select:

- A wash programme together with the *Short* extra option for light to normal soiling where there are no obvious marks.
- A wash programme without any extra options for normal to heavy soiling with visible staining.
- A wash programme together with the *Soak* extra option for very heavily soiled laundry.
- The *Pre-wash* extra option for laundry with large amounts of dirt (e.g. dust, sand).

When drying with a tumble dryer

Selecting the highest possible spin speed for the wash programme will save energy when drying in a tumble dryer afterwards.

How to wash correctly

Brief instructions

The headings numbered ①, ②, ③, . . . show the operating sequence and can be used as brief instructions.

① Sort the laundry

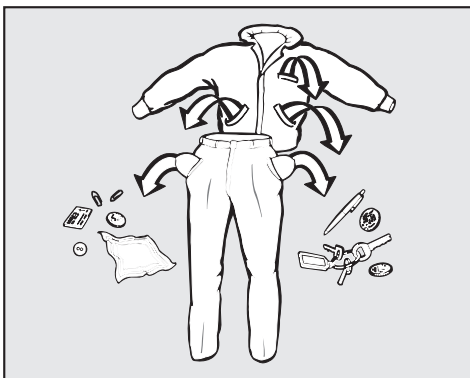

- Empty all pockets.

⚠ Foreign objects (e.g. nails, coins, paper clips, etc.) can cause damage to garments and components in the machine.

- Badly soiled areas, stains etc. should be cleaned as soon as possible, preferably whilst still fresh. Spillages should be carefully dabbed off using a soft colourfast cloth. Do not rub!

Badly soiled areas can be pre-treated with liquid detergent, stain removers etc. first, following the manufacturer's instructions. With particularly stubborn stains ask your dry cleaner for advice.

⚠ If you use a solvent-based cleaning agent (e.g. one containing benzene) to pre-treat a stain, make sure that any plastic parts (e.g. buttons) are protected, and that the cleaning agent is rinsed off before washing the garment in the machine.

⚠ Do not use solvent-based cleaning agents in or on this machine.

- Sort the laundry by colour and by care label. Most garments have a textile care label in the collar or side seam.

Dark textiles often contain excess dye and should be washed separately several times before being included in a mixed load. Always wash whites and coloureds separately.

- Curtains: Remove lead weights first or place in a laundry bag.
- Underwiring and collar stiffeners: Any loose wiring in bras, shirt collar stiffeners, etc. should be removed or sewn in.
- Knitted garments, trousers and jeans, T-shirts and sweat shirts: Turn inside out, if recommended by the manufacturer.
- Close any zips, fasten hooks and eyes etc before washing.
- Fasten duvet covers etc. to prevent small items from being rolled up inside them.

Do not wash any items in this machine which are specified by the manufacturer as **not washable** on the care label. (☒ symbol)

How to wash correctly

2 Switch on the washing machine

The interior drum lighting will come on.

The drum lighting will go out automatically after five minutes. Press the *Door* button to switch the drum lighting back on again.

The display will ask you to select a programme.

3 Select a programme

Via the programme selector:

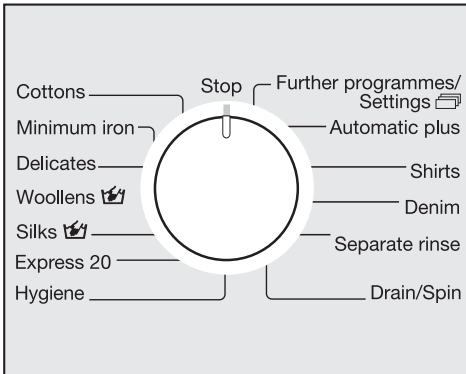

- Turn the programme selector to the required programme.

The following are selected via *Further programmes/Settings*

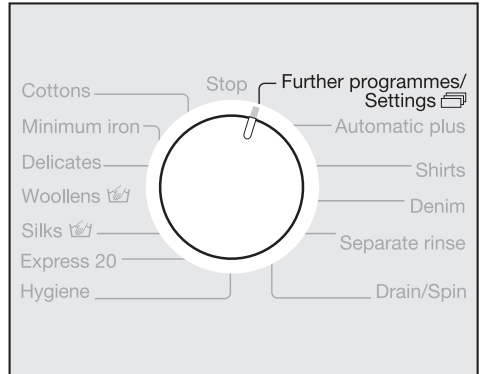

- When you turn the programme selector to *Further programmes/Settings* , these will appear in the display.



- Press the ∇ or \blacktriangle button to scroll through the options until the programme you want is highlighted and confirm your selection by pressing the **OK** button.

The programme selected will appear in the display.

How to wash correctly

④ Select a temperature / spin speed

If required, you can change the suggested temperature and/or spin speed within a given range.

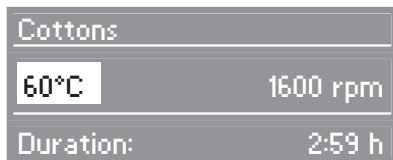

- Press the \vee or \wedge button to alter the temperature.
- By pressing the **OK** button you switch to changing the spin speed and back again.

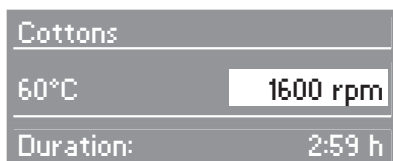

- Press the \vee or \wedge button to alter the spin speed.

⑤ Select an Extra option(s)

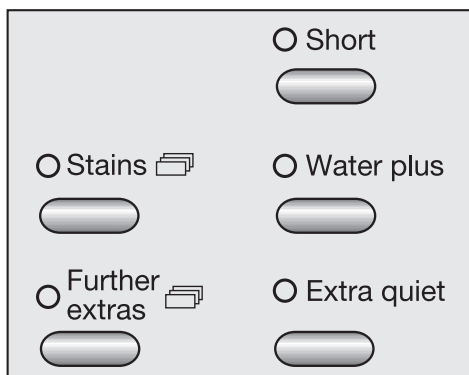

- Select any extra options by pressing the appropriate button. The relevant indicator light will come on to show which extra option has been selected.
- Press the *Further extras* button to select the following extra options (depending on the programme selected): *Extra rinse*, *Pre-wash*, *Soak* or *Rinse hold*.

Not all the extra options are suitable for use with every programme.

You can only select extra options which are compatible with the programme being used.

See "Extra options" for more information.

How to wash correctly

⑥ Load the drum

- Press the *Door* button to open the drum door.

The load size indicator display will appear.



The display shows the amount of laundry loaded in the drum as a % (in 25% steps) of the maximum load permissible for the programme selected.

- Unfold the laundry and load loosely into the drum. Mixing both large and small items gives better wash results and also helps distribute the load evenly during spinning.

The most efficient use of energy and water is achieved when a full load is washed. However, do not overload as this causes creases and reduces cleaning efficiency.

Make sure that no items are caught between the drum door and seal.

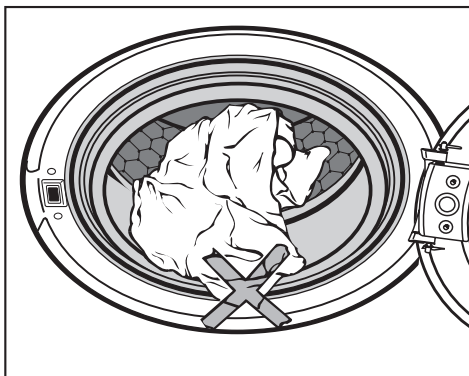

- Shut the door with a gentle swing.

How to wash correctly

7 Add detergent

When the door is closed, the load size indicator will be replaced with the detergent percentage display.

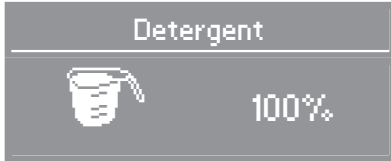

The percentage shown relates to the amount of detergent recommended by the manufacturer on the packaging.

- 40%** = Add slightly less than half the amount recommended
- 50%** = Add half the amount recommended
- 60%** = Add slightly more than half the amount recommended
- 75%** = Add three quarters of the amount recommended
- 100%** = Add the full amount of detergent recommended

You also need to take the level of soiling and water hardness into account.

It is important to dispense the correct amount, because

too little detergent results in:

- Laundry not getting properly clean and with time it may become grey and hard to the touch.
- Greasy particles clinging to laundry.
- Limescale deposits on the heater elements.

too much detergent results in:

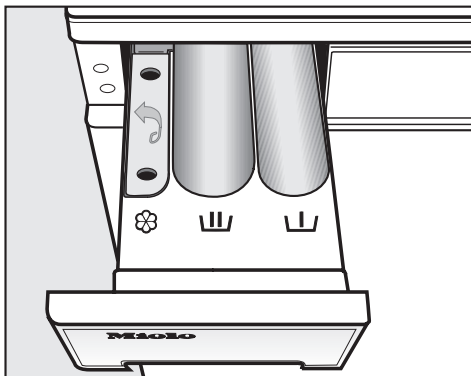

- Excessive foam which causes a low level of agitation and poor wash, rinse and spin results.
- High water consumption (an additional rinse cycle will automatically switch in).
- A burden to the environment.

How to wash correctly



- Pull out the detergent drawer and add detergent to the compartments as follows:



Detergent for the pre-wash (divide the total recommended amount as follows: add $\frac{1}{3}$ to compartment  and $\frac{2}{3}$ to compartment )



Detergent for the main wash, including Soak if selected



Fabric conditioner or liquid starch

- Close the detergent drawer.

See "Detergent" for further information.

8 Select Delay start (if required)

- Press the  button and set the time you wish the programme to end at.

See "Delay start" for more information.

9 Start the programme

- Press the flashing *Start/Stop* button.

If a delay start time has been set, then this will count down in the display. At the end of the delay start time or immediately after the programme has started (if no delay start time has been selected) the estimated programme duration will appear in the display. During the first 8 minutes the machine measures how much water is being absorbed by the laundry. The programme duration may be longer or shorter depending on this absorbency rate.

The programme sequence is also shown in the display. The washing machine lets you know which section of the programme has been reached.

The drum lighting switches off once the programme has started.

How to wash correctly

9 Remove the laundry when the programme has finished

In the anti-crease phase after the programme has finished, the following will appear alternately in the display:

Cottons	
60°C	1600 rpm
Anti-crease	

and

i Programme finished
Unload the drum
before switching off

- Press the *Door* button to open the drum door.

The washing machine will switch off automatically 15 minutes after the end of the anti-crease phase. You will need to press the ① button to switch it back on again.

- Remove the laundry.

Check that all items have been removed from the drum. Items left in the drum could discolour other items in the next wash or become discoloured themselves.

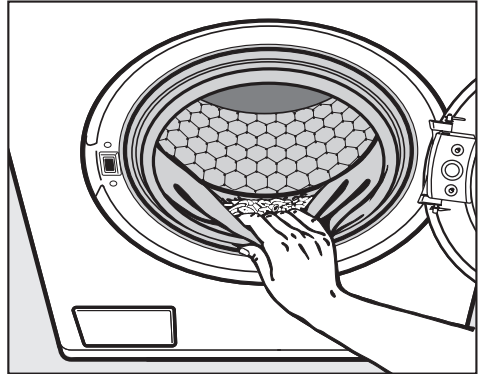

- Check the folds in the door seal for any small articles, e.g. buttons, which might be lodged there.

Important
Always remove the laundry before switching the machine off. This is important to ensure that the load size indicator works correctly.

- Turn the programme selector to the *Stop* position.
- Switch the machine off with the ① button.
- Close the drum door. Otherwise there is the danger of objects being placed inadvertently in the drum. If these remained unnoticed and were washed in the next load, they could damage the laundry.

Extra options are selected or deselected by pressing the appropriate button.

Short

For light to normal soiling with no visible staining.

The duration of the main wash is reduced.

Water plus

The water level in the main wash and the rinses will be increased.

Stains

There is a choice of various types of stains for achieving the optimum wash result with stain removal. Extra options will be added to the wash programme automatically, depending on the type of stain selected. With some stains, a tip about pre-treating the stain will appear in the display. You can select a maximum of three stains with each programme.

If the "Short" extra option was selected previously, it will be deselected automatically.

Press the *Stains*  button again to come out of the *Stains* sub-menu.

Extra quiet

If using your washing machine during quiet periods, you can reduce the noise levels even more.

If the *Extra quiet* extra option is selected, the machine will activate the *Rinse hold* extra option and not spin. The programme duration is longer.

To deactivate Rinse hold

- Press the *Further extras*  button.

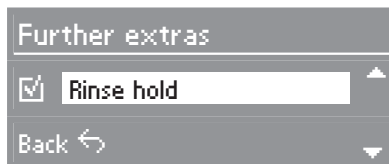

- Press the \vee or \wedge button until *Rinse hold* is highlighted and deactivate it with the **OK** button.

The following will appear in the display:

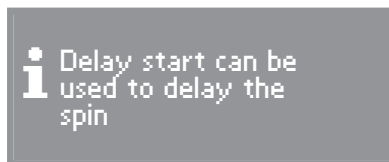

By using Delay start you can make sure the final spin occurs outside quiet periods in the home.

Extra options

Further extras

The Further extras sub-menu will open in the display.

Press the *Further extras*  button again to come out of the *Further extras* sub-menu.

Extra rinse

An additional rinse cycle is carried out to achieve a better rinse result.

Pre-wash

For laundry with large amounts of dirt e.g. dust, sand.

Soak

For heavily soiled items with protein stains.

A duration of between 30 minutes and 6 hours can be chosen in 30 minute increments for the soak process.

– To select the soak duration

- Press the *Further extras*  button.

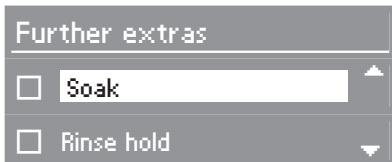

- Press the ∨ or ∧ button until *Soak* is highlighted and confirm it with the **OK** button.

You can now use the display to select the soak duration you require.

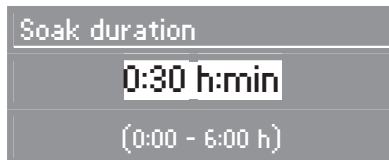

- Use the ∨ or ∧ button to select the soak duration you want and confirm it with the **OK** button.

– To delete the soak duration

- Press the *Further extras*  button.

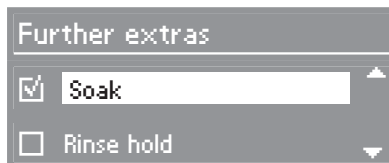



- Press the ∨ or ∧ button until *Soak* is highlighted and deselect it with the **OK** button.

Rinse hold

The laundry will not be spun and will remain suspended in the final rinse water. This reduces creasing if the laundry is not going to be removed from the drum immediately after the end of the programme.

The following extra options can be selected in addition to the programme:

	Short	Water plus	Stains 	Extra quiet	Extra rinse	Pre-wash	Soak	Rinse hold
Cottons	*	*	*	*	*	*	*	*
Minimum iron	*	*	*	*	*	*	*	*
Delicates	*		*	*		*	*	*
Woolens 								*
Silks 		*			*			*
Express 20	* ¹⁾	*		*	*			*
Hygiene		*	*	*	*	*	*	*
Automatic plus			*	*				*
Shirts	*	*	*	*	*	*		*
Denim	*		*	*		*	*	*
Separate rinse				*				*
Drain / Spin								
Dark garments	*		*	*				*
Sportswear	*	*	*	*	*	*	*	*
Trainers						* ²⁾		*
Outerwear	*	*	*	*	*	*	*	*
Proofing				*				*
Soft toys			*	*				*
First wash		*		*	*			*
Pillows		*	*	*	*			*
Curtains		*	*	*	*	* ²⁾		*
Starch				*	*			*

¹⁾ This extra option is activated automatically as part of programme but can be deselected.

²⁾ This extra option is activated automatically as part of the programme and cannot be deselected.

Spinning

Final spin speed

Programme	rpm
Cottons	1600
Minimum iron	1200
Delicates	600
Woolens 	1200
Silks 	600
Express 20	1600
Hygiene	1600
Automatic plus	1200
Shirts	600
Denim	900
Separate rinse	1600
Drain / Spin	1600
Dark garments	1200
Sportswear	1200
Trainers*	1000
Outerwear*	800
Proofing	1000
Soft toys	900
First wash	1200
Pillows*	1200
Curtains	600
Starch	1600

You can reduce the final spin speed. However, you cannot select a final spin speed higher than that shown in the chart above.

Rinse and interim spin

There is a spin after the main wash and between the rinses. A reduction in the final spin speed will also reduce the interim spin speed. In some programmes, an additional rinse is introduced if a spin speed of less than 700 rpm is selected.

To omit the final spin (Rinse hold)

■ Press the *Further extras*  button and select the *Rinse hold* option.

– To start the final spin and end the programme:

The washing machine will display the maximum spin speed possible. You can use the ∇ button to select a lower spin speed. Start the final spin by pressing the *Start/Stop* button.

– To end the programme without the final spin:

Press the *Door* button. The water will drain away. Press the *Door* button again to open the door.

To omit rinse and interim spin and the final spin (No spin)

■ Select *No* .

The laundry is not spun after the final rinse. The water will drain away and the machine will go straight into the anti-crease stage. With some programmes an additional rinse is introduced if this setting is selected.

With delay start you can choose when you want the programme to end. The start of a programme can be delayed from 15 minutes up to a maximum of 24 hours, allowing you to make use of night-time economy electricity rates, for example.

The current time of day needs to have been set for delay start to work correctly.

To select delay start

- 1 Select the programme you want and then press the ⊕ button.

The display shows:

Delay start	8:20
Start time	8:20
Finish time	11:19

- 2 Press the ^ button to select the time you want the programme to end at.

The first press on the button will adjust the programme end time to the next 15, 30, 45 minutes or full hour. Each subsequent press on the button will delay the programme end time by 15 minutes.

Delay start	8:20
Start time	15:01
Finish time	18:00

- 3 Confirm your selection by pressing the **OK** button.
- 4 Press the *Start/Stop* button.

The display will show the hours and minutes remaining until the start of the programme.

To change delay start

You can select a later or earlier programme end time subsequently, if you wish.

- Press the ⊕ button.
- Use the ∨ or ^ button to change the programme end time.
- Confirm your selection by pressing the **OK** button.

To cancel delay start

- Press the *Start/Stop* button.



The following will appear in the display:

Options
Cancel delay start
Activate safety lock









- Confirm your selection by pressing the **OK** button.
- Now you can select a different programme, or
- press the *Start/Stop* button to start the programme straight away.

The actual load size can only be determined accurately by the machine once the programme has started. The programme end time may, therefore, be a bit later or earlier than first indicated.

Programme chart

Cottons		cold to 95°C	Max. load 7.0 kg
Use for	Cotton, linen or cotton mix fabrics, e.g. table linen, towelling, underwear, T-shirts etc.		
Note	<ul style="list-style-type: none"> – Selecting the 60°C wash temperature will give the performance of a Cottons 60°C programme, however for energy saving and environmental protection reasons the actual wash temperature reached will be lower. – Where higher levels of hygiene are required please select a temperature of 75°C or above or use the <i>Hygiene</i> programme. 		
Note for test institutes:			
Short programme: 3.5 kg load and <i>Short</i> extra option			
Minimum iron		cold to 60°C	Max. load 3.5 kg
			
Use for	Synthetic, mixed fibre and easy care cotton. If fabrics have a high proportion of man-made fibres it is advisable to programme the machine for "Gentle action". See "Settings menu".		
Note	Reduce the spin speed for fabrics which crease easily.		
Delicates		cold to 60°C	Max. load 2.5 kg
			
Use for	Delicate garments made of synthetic fibre, mixed fibre, rayon and easy care cotton.		
Note	Deselect the spin for items which crease easily.		
Woolens		cold to 40°C	Max. load 2.0 kg
			
Use for	Machine-washable or hand-washable wool or wool blend fabrics. If the care label does not specify a temperature, wash using the cold setting.		
Note	Reduce the spin speed for items which crease easily.		

Programme chart

Silks 		cold to 30°C	Max. load 1.0 kg
Use for	Silks and other handwashable fabrics with no wool content.		
Note	Place tights, bras etc. in a washing bag.		
Express 20   *		cold to 40°C	Max. load 3.5 kg
Use for	Cotton and minimum iron garments that have hardly been worn or are only very lightly soiled.		
Note	The Short extra option will be activated automatically.		
Hygiene		30°C to 95°C	Max. load 7.0 kg
Use for	Cotton and linen fabric which have been in direct contact with the skin, e.g. underwear, nappies, towelling, bed linen, pillow and mattress covers or where high standards of hygiene are required.		
Notes	<ul style="list-style-type: none"> – For optimum hygiene results select a temperature of 60°C or above. – Observe the manufacturer's care label. 		
Automatic plus     *		cold to 40°C	Max. load 5.0 kg
Use for	Mixed loads of garments suitable for the <i>Cottons</i> and <i>Minimum iron</i> programmes. Sort according to colour.		
Note	The wash parameters (e.g. water level, wash rhythm and spin speed) are adjusted automatically in this programme to ensure the best possible care and wash result for each item.		
Shirts		cold to 60°C	Max. load 2.0 kg
Notes	<ul style="list-style-type: none"> – Pre-treat collars and cuffs if necessary. – Wash silk garments in the <i>Silks</i>  programme. 		
Denim		cold to 60°C	Max. load 3.0 kg
Notes	<ul style="list-style-type: none"> – Wash denim inside out. – Denim often contains excess dye and may run during the first few washes. Wash light and dark coloured items separately. 		

* Please note that the "buckets" represent garment care label symbols. See "Garment care label symbols".

Programme chart

Separate rinse		Max. load 7.0 kg
Use for	Rinsing handwashed items.	
Note	– Reduce the spin speed for fabrics which crease easily.	
Drain / Spin		
Notes	<ul style="list-style-type: none"> – Drain only: Select <i>No</i> Ⓞ (No spin). – Make sure you select the appropriate spin speed. 	
Dark garments		cold to 40°C Max. load 3.0 kg
Use for	Black and dark garments made from cotton or mixed fibre.	
Note	Wash inside out.	
Sportswear		cold to 60°C Max. load 3.0 kg
Use for	Sportswear such as singlets and leggings as well as microfibre and fleece garments.	
Notes	<ul style="list-style-type: none"> – Do not use fabric conditioner. – Observe the manufacturer's care label. 	
Trainers		cold to 40°C Max. 2 pairs of shoes
Use for	Sports shoes only (do not use for leather shoes)	
Notes	<ul style="list-style-type: none"> – Observe the manufacturer's care label. – Remove coarse soiling with a brush before washing. – Fasten any velco fasteners. – Do not use fabric conditioner. – A pre-rinse without detergent is carried out automatically to remove loose dirt. – Use a drying basket if drying in a tumble dryer. 	
Outerwear		cold to 40°C Max. load 2.5 kg
Use for	Outerwear made from membrane fabrics such as Gore-Tex®, SYMPATEX®, WINDSTOPPER® etc.	
Notes	<ul style="list-style-type: none"> – Zip up jackets before washing. – Do not use fabric conditioner. – If wished these garments can also be re-proofed using the <i>Proofing</i> programme. Proofing should not be done every time the garment is washed. 	

Programme chart

Proofing		40°C	Max. load 2.5 kg
Use for	Treating microfibre fabrics, skiwear, and table linen made from mainly synthetic fibres to provide a water and stain resistant finish.		
Notes	<ul style="list-style-type: none"> – The items should be freshly laundered and spun or dried before proofing. – For best results, the items should be heat-treated afterwards, either in a tumble dryer or by ironing. 		
Soft toys		cold to 40°C	Max. load 1.0 kg
Use for	Soft toys, specified as machine-washable by the manufacturer.		
Note	Do not wash soft toys stuffed with straw.		
First wash		cold to 40°C	Max. load 3.0 kg
Use for	New items made of cotton, towelling and polyester fabric.		
Note	Use this programme to wash any manufacturing residues out of new items.		
Pillows		cold to 95°C	2 pillows (40 x 80 cm) or 1 pillow (80 x 80 cm)
Use for	Washable pillows with feather, down or synthetic fillings.		
Note	Please observe the instructions on the wash care label.		
Curtains		cold to 40°C	Max. load 2.0 kg
Use for	Curtains, including net curtains, specified as machine-washable by the manufacturer.		
Notes	<ul style="list-style-type: none"> – A pre-rinse without detergent is carried out automatically to remove dust. – For curtains which crease easily, reduce the final spin speed or deselect the spin. – Remove weights from curtains. 		
Starch			Max. load 7.0 kg
Use for	Starching table cloths, serviettes and workwear		
Notes	<ul style="list-style-type: none"> – Reduce the spin speed for fabrics which crease easily. – The laundry should be washed but not treated with fabric conditioner. 		

Programme sequence

	Main wash		Rinses		Spinning	
	Water level	Wash rhythm	Water level	Rinses	Interim spin	Final spin
Cottons		(A)		2-4 ¹⁾²⁾	✓	✓
Minimum iron		(C)		2-3 ³⁾	✓	✓
Delicates		(D)		3	–	✓
Woollens 		(F)		2	✓	✓
Silks 		(F)		2	–	✓
Express 20		(B)		1-3 ³⁾	✓	✓
Hygiene		(B)		3-4 ²⁾	✓	✓
Automatic plus		(A)(B)(C)		2-3 ³⁾	✓	✓
Shirts		(C)		2	–	✓
Denim		(C)		3	–	✓
Separate rinse	–	–		2	–	✓
Drain / Spin	–	–	–	–	–	✓
Dark garments		(B)		3-4 ³⁾	✓	✓
Sportswear		(C)		2-3 ³⁾	✓	✓
Trainers ⁶⁾		(E)		2	–	✓
Outerwear		(D)		3	✓ ⁴⁾	✓
Proofing		(D)	–	–	–	✓
Soft toys		(C)		3	✓	✓
First wash		(B)		2-3 ³⁾	✓	✓
Pillows		(D)		3	–	✓
Curtains ⁶⁾		(D)		3	–	✓
Starch		(C)	–	–	–	✓

Please see next page for description of the symbols

 = Low water level

 = Medium water level

 = High water level

(A) = Intensive rhythm

(B) = Normal rhythm

(C) = Gentle rhythm

(D) = Sensitive rhythm

(E) = Ultra sensitive rhythm

(F) = Handwash rhythm

This machine has fully electronic controls with automatic load recognition. It takes in the right amount of water required for the programme depending on the amount of laundry and its absorbency rate. This means that programme cycles and durations can vary.

The programme sequences outlined in the chart are based on the basic programme with a full load. Extra options which can be selected have not been taken into account.

The display shows the stage the programme has reached.

Special features in the programme sequences:





Anti-crease:



At the end of every programme, with the exception of the Woollens programme, the drum continues to turn at intervals for up to 30 minutes to help prevent creasing.





The door can be opened and laundry removed at any time during the anti-crease phase.





- 1) A second rinse is carried out when a temperature between 60°C and 95°C has been selected. A third rinse is carried out when a temperature below 60°C is selected.
- 2) A third or fourth rinse is carried out if:
 - there is too much foam in the drum
 - a spin speed lower than 700 rpm has been selected
 - The spin speed has been deselected.
- 3) A third rinse is carried out if:
 - The spin has been deselected.
- 4) In the *Outerwear* programme, laundry is only spun after the main wash.
- 5) Run-up to spin: A run-up to spin is carried out before the wash process begins, to deflate down-filled items. Subsequent water intake for the main wash is through compartment .
- 6) Pre-rinse: A pre-rinse without detergent is carried out automatically to remove dust.



Garment care label symbols

Washing	
The figure quoted in the bucket is the maximum temperature the garment can be washed at. The number of bars under the symbol indicates the level of agitation permitted.	
	No bar under the symbol: = normal agitation
	One bar under the symbol: = reduced agitation
	Two bars under the symbol: = much reduced agitation
	Hand wash (if no temperature is specified use the lowest temperature or cold)
	Do not wash

Drying	
The number of dots indicates the drying temperature	
	Normal temperature
	Low temperature
	Do not tumble dry

Ironing	
The number of dots indicates the ironing temperature	
	Hot iron (max sole plate temp. approx. 200°C)
	Medium hot iron (max sole plate temp. approx. 150°C)
	Cool iron (max sole plate temp. approx. 110°C). Do not steam iron garments carrying this symbol.
	Do not iron

Professional cleaning	
	Dry clean only. The letters indicate the type of cleaning agent required.
	
	Professional Wet Clean only
	Do not dry clean

Bleaching	
	Any oxidising bleaching agent can be used
	Only use an oxygen based bleach or a non-chlorine bleach
	Do not bleach

Changing the programme sequence

Cancelling a programme

You can cancel a programme at any time after it has started.

- Press the *Start/Stop* button.



- Press the **OK** button.

The suds will be pumped away.

If you want to remove the laundry:

- Press the *Door* button.

If you want to select a different programme:

- Switch the machine off with the ① button.
- Switch the machine back on again.
- Check that there is still detergent in the detergent drawer. Add detergent, if necessary.
- Select and start a new programme.

Interrupting a programme

- Switch the machine off with the ① button.

To continue with the same programme:

- Switch the machine back on with the ① button.

Changing a programme

After the start of a programme it is no longer possible to select a different programme.

Temperature

It is possible to select a different temperature up to 5 minutes after the programme has started.

Spin speed

It is possible to change the spin speed up until the final spin begins.

Extra options

With the exception of the *Express 20* programme, it is possible to select or deselect the *Short* and *Water plus* extra options up to 5 minutes after the programme has started.

It is not possible to make any changes if the safety lock has been activated.

Changing the programme sequence

Adding or removing laundry after a programme has started

- Press the *Door* button to open the drum door.
- Add or remove items.
- Close the drum door.

The programme will continue automatically.

Please note:

Once a programme has started the machine cannot recognise any adjustment to the load.

For this reason, if laundry is added or removed after the start of a programme, the machine will always complete the programme cycle assuming a full load which can lead to a change in the programme duration shown in the display.

The door cannot be opened, if:

- the suds temperature is above **55°C**.
- the water is above a certain level.
- the programme has reached the *Final spin* stage.

If you press the *Door* button when the above conditions are present, the following will appear in the display:

Door locked

Safety lock

The safety lock prevents the machine from being opened or the programme cancelled during a wash programme.

To activate the safety lock

- Press the *Start/Stop* button in after the programme has started.



- Press the ∇ button until *Activate safety lock* is highlighted and confirm by pressing the **OK** button.

The following will appear in the display:

 **Locked**

The safety lock is now activated. It is deactivated automatically at the end of the programme.

To deactivate the safety lock

- Press the *Start/Stop* button.

The following will appear in the display:

Deactivate safety lock

- Press the **OK** button. The following will appear in the display:

 **Unlocked**

The correct detergent



All modern detergents produced for automatic washing machines are suitable.

Use dispensing aids, e.g. balls, if these are supplied with the detergent. Tablets are suitable for full loads, but note that it may be impractical to reduce tablets for smaller loads. Some tablets do not dissolve as rapidly as others, and may not be suitable for programmes with short durations.



Do not use biological detergents on silk as the enzymes may damage the silk. Instructions for use and recommended dosage amounts are given on the detergent packaging.

See "Optional accessories" at the end of this booklet for details of Miele branded care products including detergents and fabric conditioner.

Detergent

	Universal detergent	Detergent for coloureds	Detergent for delicates	Specialist detergent*	Proofing agent**	Fabric conditioner
Cottons	X	X	–	–	–	X
Minimum iron	X	X	–	–	–	X
Delicates	X	X	X	–	–	X
Woolens 	–	–	–	X	–	X
Silks 	–	–	–	X	–	X
Express 20 ¹⁾	X	X	–	–	–	X
Hygiene ²⁾	X	–	–	–	–	X
Automatic plus	X	X	–	–	–	X
Shirts	X	X	–	–	–	X
Denim ¹⁾	X	X	X	–	–	X
Dark garments ¹⁾	X	X	X	–	–	X
Sportswear ¹⁾	X	X	–	X	–	–
Trainers ¹⁾	–	X	–	–	–	–
Outerwear ¹⁾	–	–	X	X	–	–
Proofing	–	–	–	–	X	–
Soft toys ¹⁾	–	X	X	–	–	X
First wash	X	X	–	–	–	X
Pillows ¹⁾	X	X	X	X	–	–
Curtains ²⁾	X	X	–	X	–	–
Starch	–	–	–	X	–	–

1) Liquid detergent

For programmes with a pre-wash you will need to purchase a special container from the Miele Spare Parts Department which sits in the main wash compartment . Add liquid detergent to this container for the main wash and to compartment  for the pre-wash

2) Use powder detergent

* Specialist detergent

Detergent designed specifically for the wash programme or type of fabric.

** Only use proofing agents containing fluorochemical compounds which are stated by the manufacturer as being "suitable for use on membrane textiles".

Do not use proofing agents which contain paraffin. Add proofing agents to compartment .

Detergent

The right amount to dispense will depend on the following:

- The soiling level of the load
 - Lightly soiled
No visible dirt or stains. Possibly slight body odour.
 - Normally soiled
Visibly dirty and/or just a few slight stains.
 - Heavily soiled
Visible dirt and stains and/or dried on soiling.
- The quantity of the laundry (add the recommended amount of detergent)
- The water hardness level.
Check with your local water supplier if you do not know the hardness level in your area.

Water softeners

A water softener can be used to cut down on the use of detergents in hard water areas. Dispense according to the amount specified on the packaging. First add detergent and then the water softener.

Miele branded water softening tablets are available from the Miele Spare Parts Department or via the internet on www.miele-shop.com.

Use a quantity of detergent as for soft water.

Washing with several components

If you wash using several components (e.g. special application detergents), we recommend always dispensing the agents into compartment  in the following order:

1. Detergent
2. Water softeners
3. Stain remover

This way the agents are distributed more evenly.

Fabric conditioners and liquid starch

Fabric conditioners make garments soft to handle and help prevent static cling when tumble drying.

Starch stiffens and gives body to items of laundry, e.g. shirts, tablecloths and bed linen.

Automatic dispensing of fabric conditioner or liquid starch to laundry at the end of a programme

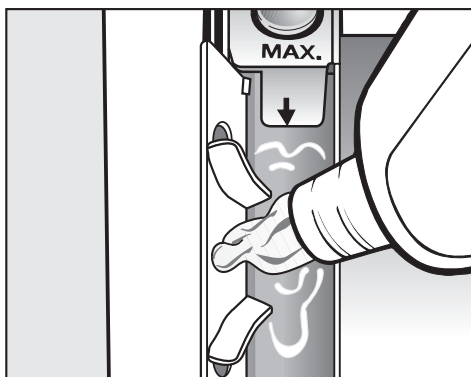

- Add the fabric conditioner or liquid starch to compartment ☼. **Do not exceed the maximum level mark.**

It will be dispensed automatically in the last rinse. At the end of the programme a small amount of water remains in the fabric conditioner compartment ☼.

If starching frequently, thoroughly clean the dispenser compartment, especially the siphon tube and fabric conditioner channel, regularly. See "Cleaning the detergent dispenser drawer". Do not use powder starch formulations or viscous liquid starch in the ☼ compartment as it will clog up.

Adding fabric conditioner or starch separately

- Dispense in accordance with manufacturer's instructions on the packaging.
- Dispense liquids into the ☼ compartment and powder or viscous formulations into the ▮ compartment.
- Turn the programme selector to *Further programmes/Settings*  and select the *Starch* programme.
- Select a spin speed or the *Rinse hold* extra option.
- Press the *Start/Stop* button.

Colour run and dye removers/dyes

- Do not use colour run or dye removers in this machine.
- Dyes suitable for use in domestic washing machines can be used. However, please note that the salt used in the dyeing process can cause corrosion to stainless steel components in the machine if you dye frequently. Follow the manufacturer's instructions carefully.

Cleaning and care

A range of Miele branded CareCollection products are available to order from Miele. See "Optional accessories".

Cleaning the drum (Hygiene info)

Washing at low temperatures and/or using liquid detergent can cause bacteria and unpleasant smells to build up in the machine. In order to clean the drum and also to prevent unpleasant smells building up, run a *Cottons 75°C* programme with powder detergent once a month or when the **Hygiene info** message appears in the display.

External casing and fascia panel

⚠ Disconnect the machine from the mains electricity supply and withdraw the plug from the socket before cleaning the machine.

⚠ The machine must not be hosed down.

- Clean the casing with a mild non-abrasive cleaning agent or soap and water using a well wrung-out cloth. Wipe dry with a soft cloth.
- Stainless steel surfaces can be cleaned with a proprietary stainless steel cleaning agent, following the manufacturer's instructions on the packaging.

⚠ Do not use solvents, abrasive cleaners, glass cleaners or multi-purpose cleaning agents. These might damage plastic surfaces and other components because of the chemicals they contain.

Cleaning the detergent dispenser drawer

The pre-wash and main wash compartments of the detergent dispensing drawer are self-cleaning. For hygiene reasons, clean the entire drawer at regular intervals.

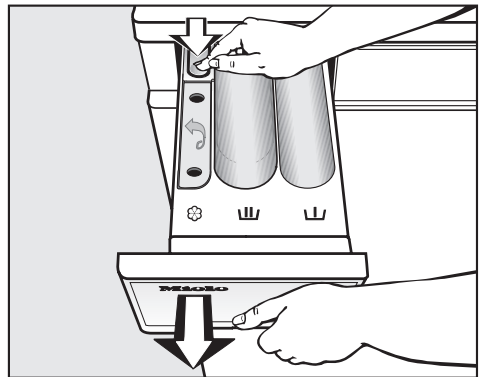

- Pull out the detergent dispenser drawer until a resistance is felt. Press down the release catch and at the same time pull the drawer right out of the machine.
- Clean the drawer with warm water.

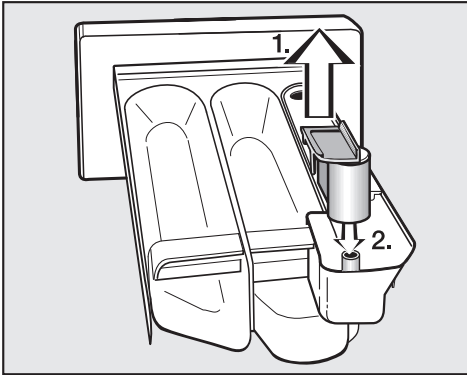

■ Clean the siphon.

1. Remove the siphon from compartment  and rinse under warm running water. Clean the siphon tube in the same way.
2. Replace the siphon.

If starching frequently, thoroughly clean the siphon and siphon tube regularly. A build-up of starch will cause them to get clogged.

Cleaning the detergent dispenser drawer housing

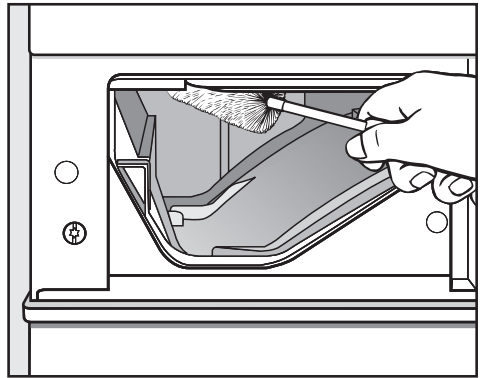

- Use a bottle brush to remove detergent residues and limescale from the jets inside the detergent dispenser drawer housing.

Cleaning and care

Cleaning the water inlet filters

The washing machine has two filters to protect the inlet valves.

These filters should be checked every six months or so, or more often if there are frequent interruptions to the water supply.

To clean the filter in the union in the open end of the inlet hose:

- First turn off the stopcock.
- Unscrew the threaded union connecting the free end of the inlet hose to the stopcock.

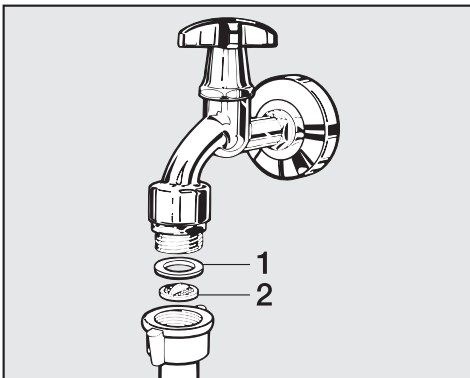

- Remove rubber seal **1** from the recess.
- Using pointed pliers, take hold of plastic filter bar **2**, remove the filter and clean it.
- Put the filter and seal back in the reverse order and reconnect the hose.
- Turn on the stopcock and check the connection is watertight. If it leaks, tighten the connection.

To clean the filter in the water inlet valve:

- Using pliers, carefully loosen the ribbed plastic nut on the inlet valve and unscrew.

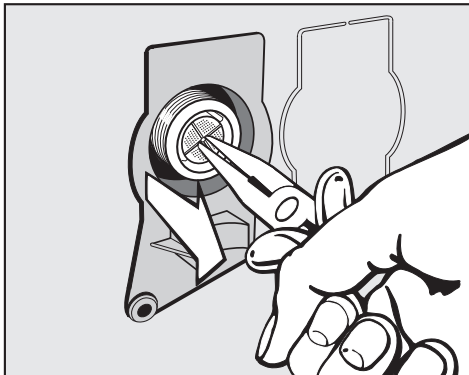

- Use pointed nose pliers to withdraw the plastic filter by the bar (see illustration). Clean, put back and secure.

The two filters **must** be put back in place after cleaning.

Problem solving guide

With the help of the following notes, minor faults in the performance of the machine, some of which may result from incorrect operation, can be put right without contacting the Service Department.





 Repair work to electrical appliances should only be carried out by a suitably qualified person in strict accordance with current local and national safety regulations. Repairs and other work by unqualified persons could be dangerous. The manufacturer cannot be held liable for unauthorised work.

The programme does not start

Problem	Possible cause	Remedy
The display remains dark and the programme selector is not lit up.	There is no power to the machine.	Check whether <ul style="list-style-type: none">– the mains plug is plugged in and switched on.– the fuse or circuit breaker has tripped.
You are asked to enter a code.	Access via a code has been activated.	Enter the code and confirm the entry. Deactivate the code if you do not wish this message to appear in the display the next time the machine is switched on.
The display is dark.	The display has switched off automatically to save energy (Standby mode).	Press a button. Standby comes to an end.

Problem solving guide

One of the following fault messages appears in the display

	Fault message	Possible cause	Remedy ¹⁾
	Fault Water intake Open stopcock	The water inlet is blocked or restricted.	Check whether <ul style="list-style-type: none"> – the stopcock is opened properly. – the inlet hose is kinked. – the water pressure is too low.
	Fault Check drainage system	<ul style="list-style-type: none"> – The water outlet is blocked or restricted. – The drain hose has been fixed too high. 	<ul style="list-style-type: none"> – Clean the drain filter and the drain pump. – The maximum delivery head is 1 m.
	Waterproof system activated Close the stopcock	The water protection system has reacted.	<ul style="list-style-type: none"> – Close the stopcock. – Call the Service Department.
	Technical fault xxx Call Service	There is a fault.	Start the programme again. If the fault message appears again, contact the Service Department.

¹⁾ To switch off the fault message: Switch the machine off with the  button.



The following fault messages appear in the display at the end of the programme

Fault message	Possible cause	Remedy
Check detergent	Excessive foam has built up during washing.	Use less detergent next time and follow the manufacturer's instructions on dosage given on the packaging.
Hygiene information.	A programme using a temperature above 60°C has not been run for a long time.	In order to prevent bacteria and unpleasant smells building up in the machine, run a <i>Cottons 75°C</i> programme using powder detergent.

Problem solving guide

Problems with the load size indicator or calibrating to zero		
Problem	Possible cause	Remedy
The display indicates a load of <25% or no load size is indicated when the drum is full.	There was already laundry in the drum when the machine was switched on. This has decalibrated the sensor from the zero setting.	<ul style="list-style-type: none"> ■ To recalibrate the sensor to the zero setting: <ul style="list-style-type: none"> – Remove the laundry from the drum. – Switch off the washing machine and leave the door open. – Switch on the washing machine. – Turn the programme selector to <i>Cottons</i>. – Press and hold the <i>Load/ Detergent</i> button pressed in until the following message appears in the display: Zero setting OK.
The display indicates a load of 25%, 50%, 75% or 100% when the drum is empty.	The load size sensor has been decalibrated from the zero setting.	Rotate the drum once. If the display still indicates a load of 25%, 50%, 75% or 100% , recalibrate the sensor to zero again (see above section).
The fault message: Zero setting not possible. Open the door appears in the display.	The drum door is closed.	<ul style="list-style-type: none"> – Open the drum door. – Switch off the washing machine and leave the door open. – Switch on the washing machine. – Try and recalibrate to zero again.

Problem solving guide

General problems		
Problem	Possible cause	Remedy
The machine shakes during the spin cycle.	The machine feet are not level.	Level the machine (see "Installation and connection").
The laundry has not been spun properly and is still wet.	The machine detected an imbalance during the final spin and reduced the spin speed automatically.	Include both large and small items in the load as this will give better distribution.
The laundry has not been spun satisfactorily.	The spin speed selected was too low.	Select a higher spin speed next time.
The pump makes strange noises.	This is not a fault! These noises occur at the end of a pump sequence as a normal part of the operation.	
There is a lot of detergent residue in the detergent drawer.	The water pressure is too low.	<ul style="list-style-type: none"> – Clean the water inlet filter. – Select Water plus.
	Powder detergent used with water softeners can be sticky.	Add washing powder and then add the water softener.
Fabric conditioner is not completely dispensed or too much water remains in the  compartment.	The siphon tube is not correctly positioned, or is clogged up.	Clean the siphon, (see "Cleaning and care - Cleaning the detergent dispenser drawer").
The display is in a different language.	A different language has been selected in <i>Settings Language</i>  .	Set the language you want. The flag symbol will guide you.
When laundry is dry it feels hard to the touch.	Too vigorous wash action.	Programme in gentle action and more water.
	Not enough detergent used.	Increase detergent dose to prevent limescale build up in laundry.
	No fabric conditioner used.	Use fabric conditioner in last rinse.

Problem solving guide

An unsatisfactory wash result		
Problem	Possible cause	Remedy
Liquid detergent does not give the required result.	Liquid detergents usually contain no bleaching agents. They do not remove fruit, coffee and tea stains.	<ul style="list-style-type: none"> – Use a general purpose detergent containing a bleaching agent. – Pour stain removers into compartment  of the dispenser drawer and liquid detergent into a dispenser ball. – Never put stain removers and liquid detergent together in the dispenser drawer.
Grey, greasy particles cling to washed laundry.	Insufficient amounts of detergent were used to break down the particles of grease in heavily soiled laundry.	<ul style="list-style-type: none"> – Use more detergent. – Before washing the next load run a <i>Cottons 75°C</i> programme with powder detergent but without a load.
A stale smell is in the drum and on laundry.	Low temperature washing.	<ul style="list-style-type: none"> – Before washing the next load run a <i>Cottons 75°C</i> programme with powder detergent but without a load.
White residues which look like powder detergent are seen on dark textiles after washing.	The detergent contained compounds (zeolites) to aid water softening which are not soluble in water. They have ended up on the laundry.	<ul style="list-style-type: none"> – Try and brush off the residues with a soft brush once the laundry is dry. – Wash dark textiles using a detergent which contains no zeolites. Liquid detergents usually contain no zeolites. – Use the <i>Dark garments</i> programme.
Clothes are coming out creased.	The machine was overloaded.	<ul style="list-style-type: none"> – Reduce quantity of clothes in drum.
	The wrong programme was used.	<ul style="list-style-type: none"> – Check care labels and the programme chart. – Use easy iron conditioners.

The door will not open	
Possible cause	Remedy
The machine is not connected to the electricity supply and/or is not switched on.	Insert the plug in the socket and switch on, and/or switch the machine on with the Ⓛ button.
The safety lock has been activated.	Deactivate the safety lock as described in "Changing the programme sequence - Safety lock".
Access via a code has been activated.	Deactivate the code as described in "Settings menu".
Power cut.	Open the drum door as described in the next section.
The door was not correctly engaged.	Press hard against the lock side of the drum door and then press the <i>Door</i> button.
There is still water in the drum and the machine is unable to drain.	Clean the drain filter and drain pump as described in the next section.
For safety reasons the drum door cannot be opened if the suds temperature is higher than 55°C.	

Problem solving guide

Opening the drum door in the event of a blocked drain outlet and/or power failure

- Switch the washing machine off.

There is a lever behind the detergent drawer fascia panel.

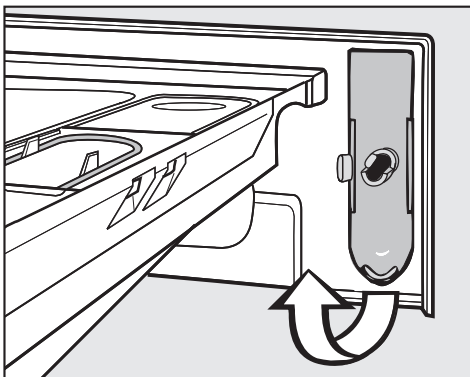

- Remove the lever.

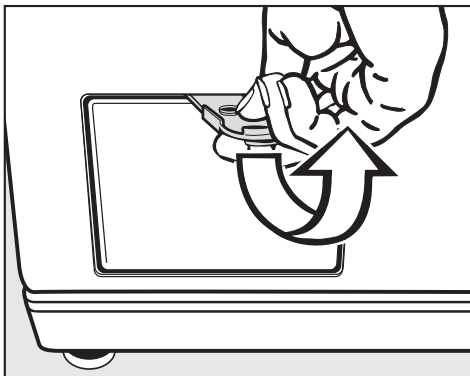

- Use it to open the access flap.

Blocked drain outlet

If the drain outlet is blocked, up to 25 litres of water will be retained in the machine.

⚠ Caution: if laundry has been washed at a high temperature, water draining out of the machine will still be hot. Danger of scalding!

Procedure for draining the machine

- Place a suitable container under the access flap.

When draining water from the machine, do **not** unscrew the drain filter completely or take it right out.



- Slowly and carefully unscrew the drain filter to let the water out.

If you need to interrupt the flow of water:

- Tighten the drain filter back up again.

Problem solving guide

Once the flow of water ceases:

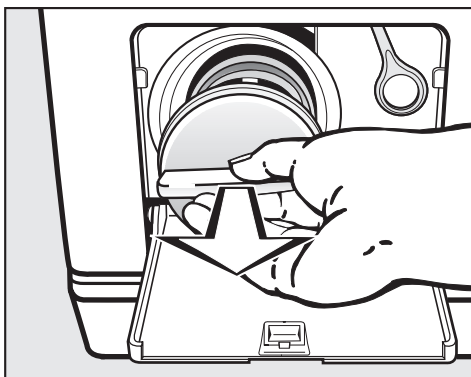

- Remove the drain filter completely.
- Clean it thoroughly.

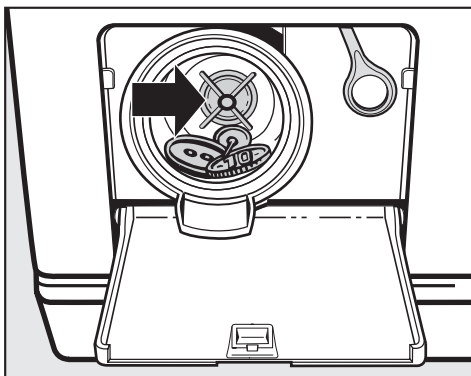

- Remove any foreign objects (e.g. buttons, coins, etc.) and fluff from the filter housing. Turn the impeller by hand to check that it rotates freely. Any foreign object causing an obstruction should be removed.
- Put the drain filter back in place and secure.

 Make sure the drain filter is securely tightened. Otherwise there is a risk of water leakage during use.

To avoid loss of detergent, pour approx. 2 litres of water into the detergent dispenser drawer after cleaning the drain filter. Excess water will be pumped out automatically before the next wash programme.

Opening the drum door

 Always make sure that the drum is stationary before reaching into the machine to remove laundry. Reaching into a moving drum is extremely dangerous.

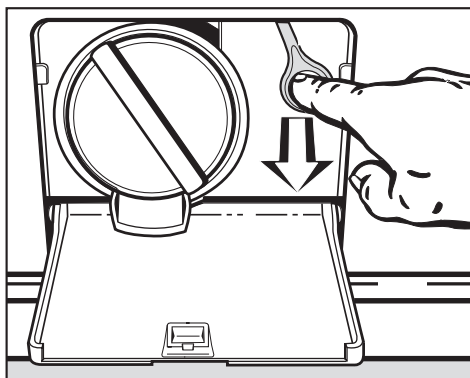

- Pull the emergency release downwards (see illustration). The drum door will open.

After sales service

In the event of any faults which you cannot remedy yourself, please contact:

- your Miele Dealer or
- Miele (see back cover for contact details).

When contacting your Dealer or Miele, please quote the model and serial number of your machine, both of which are shown on the data plate visible above the porthole glass when the door is open.

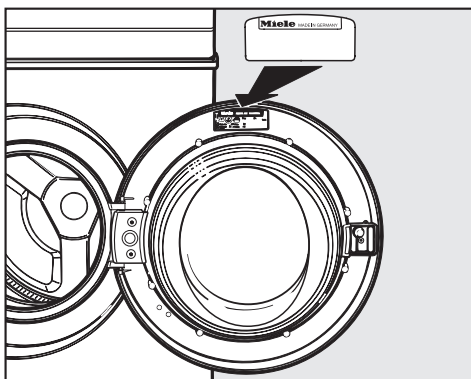

N.B. A call-out charge will be applied for service visits where the problem could have been resolved as described in these instructions.

Future updates (PC)

The indicator light marked PC is the interface used by Miele service technicians during servicing work for testing purposes and for updating the machine's programme data.

Appliance guarantee

Please see the guarantee card supplied with your machine.

Optional spare parts and accessories

Optional spare parts and accessories for this washing machine are available from your Miele Dealer, the Miele Spare Parts Department or via the internet at www.miele-shop.com.

Please note that telephone calls may be monitored and recorded for training purposes.

Installation and connection

Front view

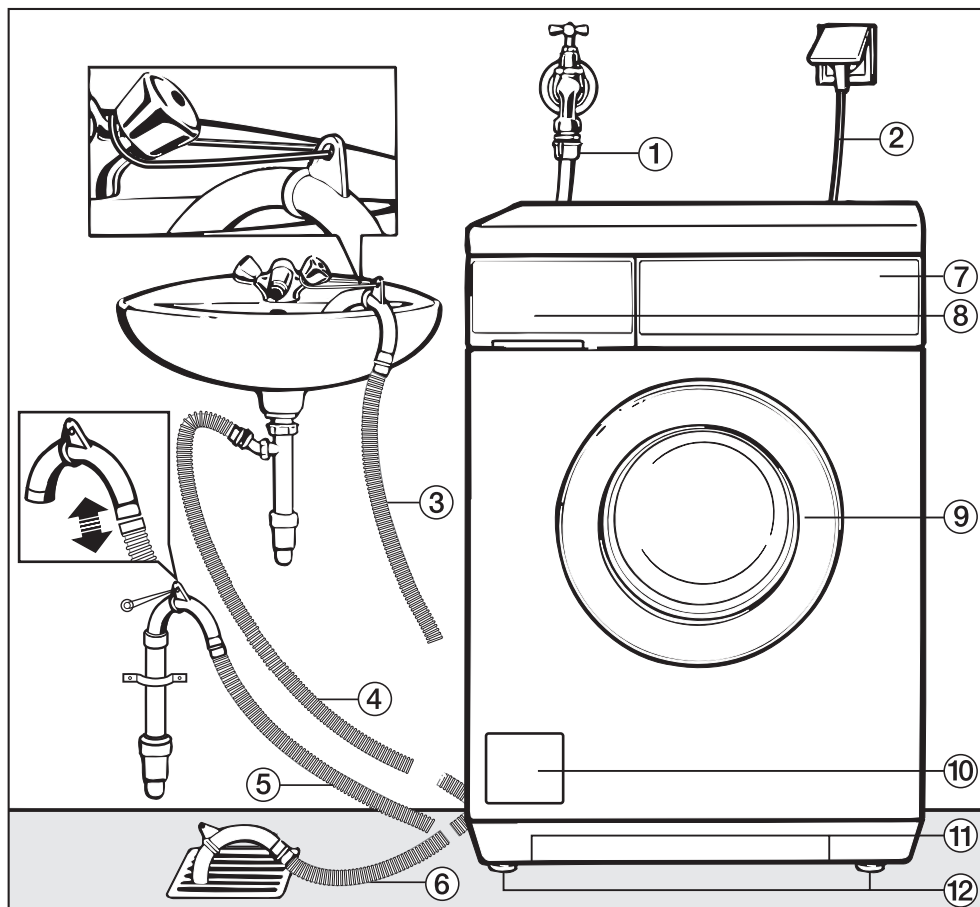

① Inlet hose (tested to withstand pressure of at least 7,000 kPa)

② Electricity supply cable

③ - ⑥ Flexible drain hose (with detachable swivel elbow)

⑦ Control panel

⑧ Detergent dispenser drawer

⑨ Drum door

⑩ Access to drain filter, drain pump and emergency release

⑪ Handle recesses for moving the machine

⑫ Four height adjustable feet

Installation and connection

Rear view

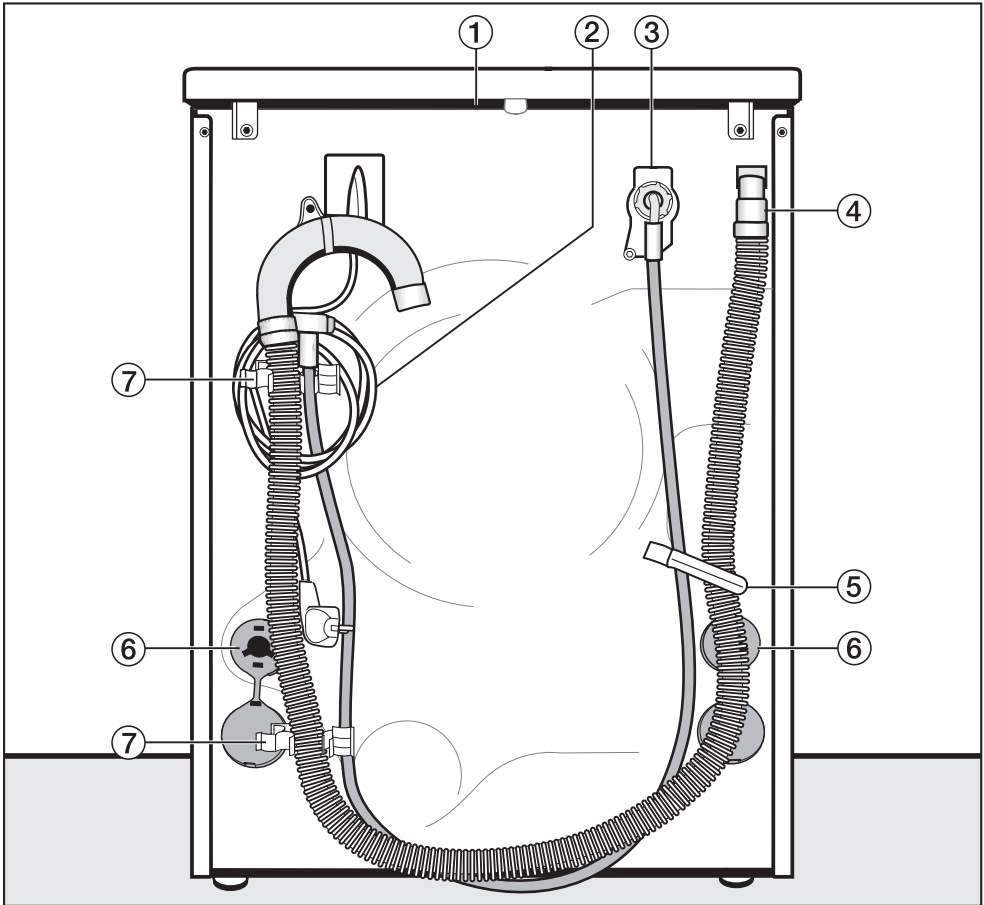

- ① Protruding lid for holding when moving the machine
- ② Electricity supply cable
- ③ Inlet hose (tested to withstand pressure of at least 7,000 kPa)
- ④ Drain hose

- ⑤ Transport clip for inlet and drain hoses
- ⑥ Safety cap for transit bars
- ⑦ Transport clip for inlet and drain hoses and for storing transit bars when not in use.

Installation surface

A concrete floor is the most suitable installation surface for a washing machine, being far less prone to vibration during the spin cycle than wooden floorboards or a carpeted surface.

Please note:

- The machine must be level and securely positioned.
- To avoid vibrations during spinning, the machine should not be installed on soft floor coverings.

If installing on a wooden joist floor:

- We recommend a plywood base (at least 59x52x3 cm). The base should span several joists and be bolted to the joists and not only to the floorboards. Check for the presence of pipes and cables first.

If possible, install the machine in a corner, as this is usually the most stable part of the floor.

 If the machine is installed on a raised plinth, it **has to be secured** against slippage during spin using retaining clips (available from the Miele Spare Parts Dept). Otherwise there is the danger of the machine moving and falling off the plinth.

Transporting the washing machine to its installation site

To manoeuvre the machine out of its packing case to its installation site, hold it by the edge of the lid where it protrudes to the rear of the machine as well as by the handle recesses at the front.

 Ensure that the machine feet and the floor are dry to prevent the machine from slipping during the spin cycle.

Removing the transit bars

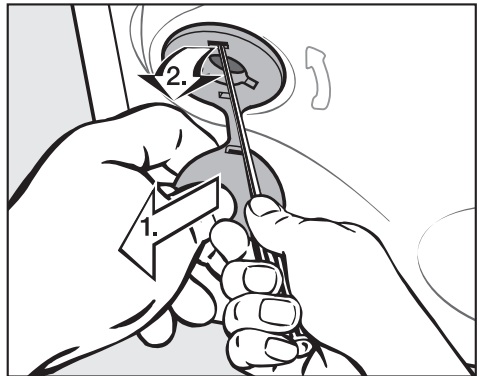

- To remove the left and right covers
 1. Pull on the attached stopper,
 2. then use a screwdriver to release the catch at the top.

Installation and connection

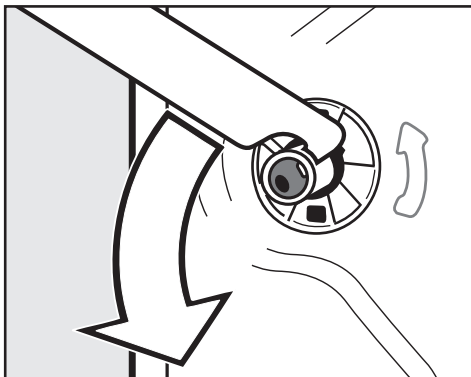

- Using the spanner supplied, turn the left-hand transit bar 90°, then

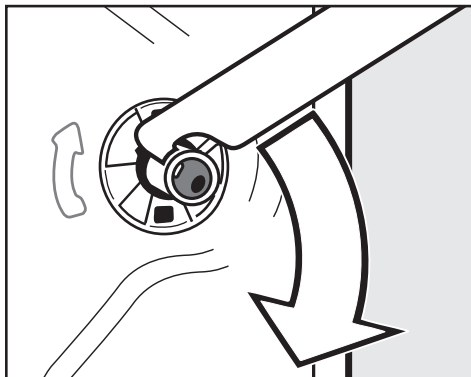

- Turn the right-hand transit bar 90°, then

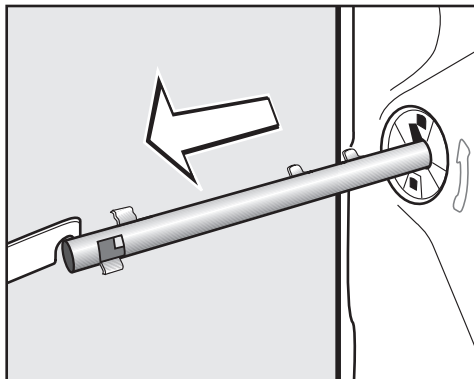

- withdraw the transit bar.

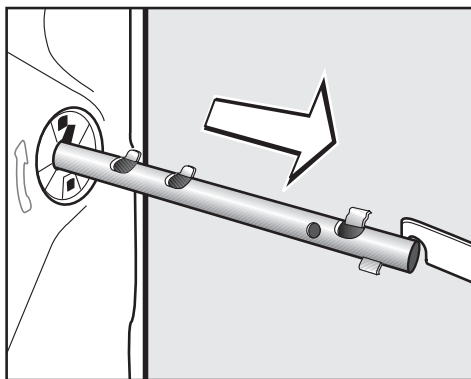

- withdraw the transit bar.

Installation and connection

 To avoid the risk of injury the holes for the transit bars must be covered after the transit bars have been removed.

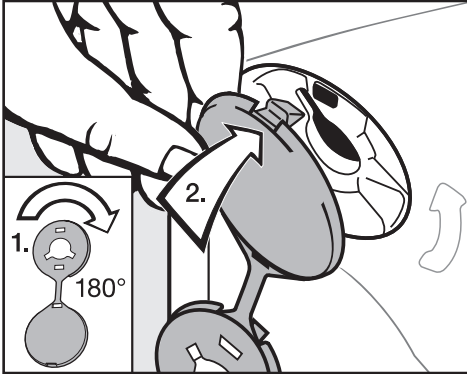

- Plug the holes with the plastic caps as illustrated.

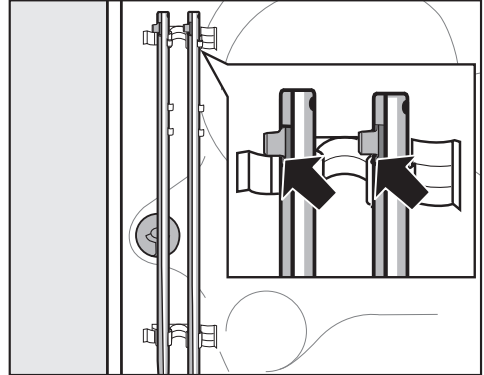

- Secure the transit bars to the back of the washing machine. Make sure that the top catch is located above the holder.

 The machine must not be moved without the transit bars in place. Store them as shown or keep them in a safe place for future use. They must be re-fitted if the machine is to be moved again (e.g. when moving house).

Re-fitting the transit bars

Re-fitting is carried out by reversing the procedure.

Installation and connection

Levelling the machine

The machine must stand perfectly level on all four feet to ensure safe and proper operation.

Incorrect installation may increase electricity and water consumption and may cause the machine to move about.

Screwing out and adjusting the feet

The four adjustable screw feet are used to level the machine. All four feet are screwed in when the machine is delivered.

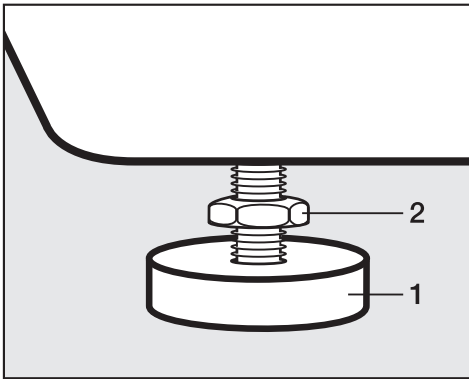

- Using the spanner supplied turn counternut **2** in a clockwise direction. Then turn counternut **2** together with foot **1** to unscrew.

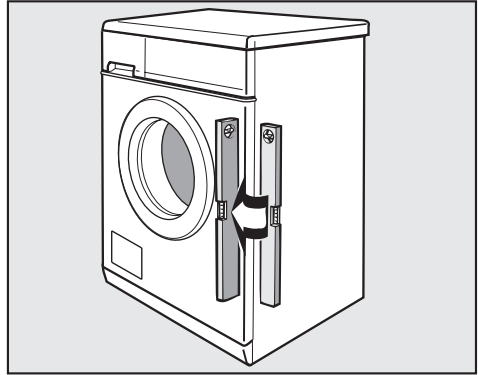

- Use a spirit level to check the machine is standing level.
- Hold foot **1** securely with a pipe wrench. Turn counternut **2** again using the spanner supplied until it sits firmly up against the housing.

 All four counternuts must be firmly up against the housing. Please also check this for the feet which did not need adjustment. Otherwise there is the danger of the machine moving about.

The fitting of building-under kits* and stacking kits* must only be undertaken by qualified and competent persons, in accordance with the instructions supplied with the kit.

Building under a continuous worktop/in a kitchen run

If you wish to push your machine under a worktop and there is space to do this **without removing the lid**, the conversion kit is not necessary. Otherwise the conversion kit is essential.

- A special building-under conversion kit* is required.
To ensure electrical safety, the washing machine lid must be replaced by the cover plate supplied with the conversion kit.
- For installation under a work surface 900/910 mm from the floor, a raising kit* is required.
- Connections for electricity, water and drainage should be installed in such a way that they remain accessible when the machine is in place.

Fitting instructions are supplied with the conversion kit.

All parts marked* are available from your Dealer, the Miele Spare Parts Department or via the internet at www.miele-shop.com.

Washer and Dryer stack

A Miele tumble dryer can be stacked with the washing machine. A "WTV" stacking kit* is necessary.

Please note:

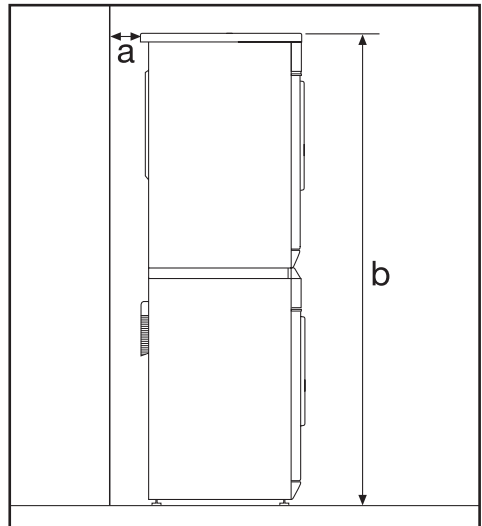

a Safety distance to wall:
at least 2 cm

b Height:
Stacking kit with pull-out shelf:
approx. 169 cm
Stacking kit without pull-out shelf:
approx. 170 cm

Installation and connection

The Miele water protection system

The Miele water protection system protects the washing machine from water damage.

The system consists of three main components:

- 1) the inlet hose
- 2) the electronic unit and the washing machine housing
- 3) the drain hose

1) Inlet hose

The inlet hose can withstand pressure of more than 7,000 kPa.

2) Electronic unit and washing machine housing

- Sump

Any leaking water is collected in a sump in the base of the machine. A float switches off the safety valves, preventing any more water flowing into the machine and water in the suds container is pumped away.

- Overflow protection

This prevents the washing machine taking in too much water. If the water level exceeds a certain level, the drain pump switches in and pumps the excess water away.

3) Drain hose

The drain hose is protected by a ventilation system which prevents the washing machine from being emptied completely.

Connection to the water supply

The machine should be connected to a mains water supply in accordance with local and national safety regulations. The German authorities do not require it to have a non-return valve as the washing machine has been designed to comply with DIN regulations.

The machine is designed to operate with a flow pressure of between 100 kPa and 1,000 kPa. If it is higher than 1,000 kPa it is essential to fit a pressure reducing valve.

Connection to the mains water supply should incorporate a mains stopcock with $\frac{3}{4}$ " thread. The stopcock should be fitted by a qualified plumber.

In order to protect the water inlet valve, the two dirt filters - one in the open end of the inlet hose, one at the inlet point in the machine - must not be removed.

Extension hose

- Longer hoses 2.5 or 4.0 m in length are available from your Miele dealer or the Miele Spare Parts Department as optional extras.

 The connection point is subject to mains water pressure. Turn on the stopcock slowly and check for leaks. Correct the position of the washer and union if appropriate.

The washing machine is **not** suitable for connection to a hot water supply.

Maintenance and care

Only use a genuine Miele hose should you ever need a replacement or extension. These are tested to withstand pressure of at least 7,000 kPa.

Installation and connection

Connection to the drainage system

The machine drains via a drain pump with a delivery head of 1 metre*. The drain hose must not be kinked as this restricts drainage. The swivel elbow at the end of the hose can be turned in either direction, or can be detached if required, with a sharp twist and pull.

If required, the drain hose can be extended to a length of 5 m. The necessary parts can be purchased from the Miele Spare Parts Department or your Miele dealer.

* For a delivery head of more than 1 m (up to a max. of 1.8 m) a replacement drain pump will need to be fitted. Please contact the Miele Spare Parts Department or your Miele Dealer.

Drain hose connection:

1. Direct into a sink or basin:

Please note the following:

- Hook the hose over the edge and secure.
 - Make sure that the water can drain away freely without hindrance. Otherwise there is a risk of water overflowing or of some of the drained water being sucked back into the machine.
2. Connected securely to a plastic drain pipe with a rubber nipple. There is no need to use a non-return valve.
 3. Connected securely to a standpipe.
 4. Connected securely to a floor gully.

Please note:

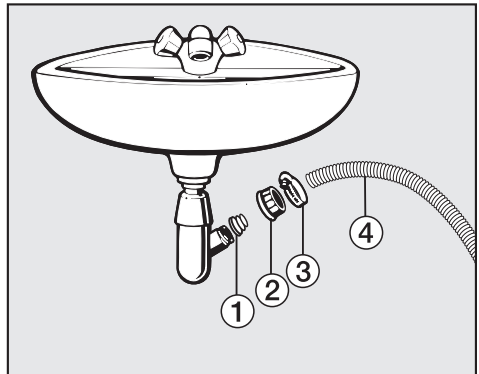

① Adapter

② Nut

③ Hose clip

④ End of the hose

- Fit adapter ① to the sink drain outlet using nut ②.
- Attach the end of the hose ④ to adapter ①.
- Use a screwdriver to tighten hose clip ③ up close to the nut.

Electrical connection U.K.

All electrical work should be carried out by a suitably qualified and competent person, in strict accordance with current national and local safety regulations (BS 7671 in the UK).

Ensure power is not supplied to the appliance until after installation work has been carried out.

The appliance is supplied with a mains cable with moulded plug ready for connection to a 230-240V mains supply.

Please ensure the connection data quoted on the data plate match the household mains supply.

Connection should be made via a suitable switched socket which is easily accessible after installation.

For extra safety it is advisable to protect the machine with a suitable residual current device (RCD). Contact a qualified electrician for advice.

Do not connect via an extension lead. Extension leads do not guarantee the required safety of the appliance (e.g. danger of overheating).

Non-rewireable plugs BS 1363

The fuse cover must be refitted when changing the fuse, and if the fuse cover is lost, the plug must not be used until a suitable replacement is obtained. The colour of the correct replacement cover is that of the coloured insert in the base of the plug, or the colour that is embossed in words on the base of the plug (as applicable to the design of plug fitted).

Replacement fuses should be ASTA approved to BS 1362 and have the correct rating. Replacement fuses and fuse covers may be purchased from your local electrical supplier.

WARNING: THIS APPLIANCE MUST BE EARTHED

Consumption data

		Load	Consumption data			
			Energy in kWh	Water in litres	Duration	
					Short	Normal
Cottons	95°C	7.0 kg	2.20	55		2 h 29 min
	60°C ¹⁾	7.0 kg	0.80	55		2 h 59 min
	60°C	3.5 kg	0.66	45		2 h 29 min
	40°C ¹⁾	7.0 kg	0.70	68		2 h 34 min
	40°C ²⁾	3.5 kg	0.58	45	1 h 10 min	
Minimum iron	40°C ¹⁾	3.5 kg	0.50	50		1 h 41 min
Delicates	30°C	2.0 kg	0.38	69	46 min	56 min
Woolens 🧶	30°C	2.0 kg	0.23	39	–	39 min
Silks 🧶	30°C	1.0 kg	0.25	39	–	36 min
Express 20	40°C	3.5 kg	0.32	30	20 min	
Hygiene	60°C	7.0 kg	1.70	80	–	2 h 35 min
Automatic plus	40°C	5.0 kg	0.52	62	–	1 h 27 min
Shirts	60°C	2.0 kg	0.95	59	1 h 01 min	1 h 11 min
Denim	40°C	3.0 kg	0.52	52	50 min	1 h 00 min
Dark garments	40°C	3.0 kg	0.58	55	1 h 02 min	1 h 12 min
Sportswear	40°C	3.0 kg	0.50	40		1 h 07 min
Trainers	40°C	1.5 kg	0.46	40	–	59 min
Outerwear	40°C	2.5 kg	0.45	55	53 min	1 h 03 min
Proofing	40°C	2.5 kg	0.35	12	–	40 min
Soft toys	30°C	1.0 kg	0.25	45	–	52 min
First wash	30°C	3.0 kg	0.25	42	–	58 min
Pillows	60°C	1.0 kg	0.90	44	–	1 h 18 min
Curtains	40°C	2.0 kg	0.45	38	–	55 min

Notes for test institutes:

1) EN 60456 test programme

2) Short programme for test institutes; the *Short* extra option must be selected.

Consumption data can vary from the nominal values given depending on water pressure, water hardness, water inlet temperature, room temperature, type and volume of load, fluctuations in the electricity supply and any extra options selected.

Technical data

Height	850 mm
Width	595 mm
Depth	615 mm
Depth with door open	993 mm
Height for building under	820 mm
Width for building under	600 mm
Depth for building under	600 mm
Weight	98 kg
Capacity	7 kg dry laundry
Voltage	See data plate
Connected load	See data plate / plug
Fuse rating	See data plate
Consumption data	See "Consumption data"
Water flow pressure minimum	100 kPa (1 bar)
Water flow pressure maximum	1000 kPa (10 bar)
Inlet hose length	1.60 m
Drain hose length	1.50 m
Mains connection cable length	1.60 m
Delivery head max.	1.00 m
Maximum drainage length	5.00 m
LEDs	Class 1
Test certificates awarded	See data plate

Settings menu

The Settings menu can be used to alter the machine's electronics to suit changing requirements. Settings can be altered at any time.

To open the Settings menu

- Switch on the washing machine.
- Turn the programme selector to *Further programmes/Settings* . The following will appear in the display:



- Confirm the selection of the highlighted *Settings*  option by pressing the **OK** button.

To select a setting

- Press the \vee or \wedge button to scroll through the options until the setting you want is highlighted and confirm your selection by pressing the **OK** button.

To close the Settings menu

- Select *Back*  or wait for approx. 15 seconds and the display will return to the programme menu automatically.

Language

The display can be set to appear in one of several different languages.

You can change the language via the Language sub-menu.

The flag after the word *Language* acts as a guide to prevent a language which will not be understood from being set.

A tick  will appear beside the language selected to show that it has been set.

Time

First select either a 24 hour or 12 hour clock. Then set the current time of day.

Clock format

- Use the \vee or \wedge button to highlight the clock format you want and confirm your selection with the **OK** button.

Set the time of day

- Select *Set the time of day* sub-menu. Use the \vee or \wedge button to set the time and confirm your selection with the **OK** button.

Gentle action

Activating gentle action reduces the drum action and is suitable for washing slightly soiled items more gently. It should be activated for garments with a single bar under the care label and for articles which feel too hard after they have been dried.

Gentle action can be activated for the *Cottons* and the *Minimum iron* programmes.

The machine is delivered with the Gentle action setting deactivated.

The option which is currently set will have a tick ✓ beside it.

Longer pre-wash Cottons

The pre-wash for the *Cottons* programme can be extended by 6, 9 or 12 minutes.

The default setting for the pre-wash is 25 minutes.

If you require a longer pre-wash, it can be extended.

The option which is currently set will have a tick ✓ beside it.

Suds cooling

When this is activated, additional water flows into the drum at the end of the main wash to cool the suds down. Hot suds can damage plastic drainage pipes.

Suds cooling takes place when temperatures of 95°C and 75°C are selected.

Suds cooling should be activated:

- to prevent the danger of scalding if the drain hose is hooked over the edge of a sink or basin.
- where the drainage pipes do not comply with DIN 1986.

The machine is delivered with Suds cooling deactivated.

The option which is currently set will have a tick ✓ beside it.

Settings menu

Lock code

The code prevents the washing machine being used without your knowledge.

When the code has been activated, you have to enter a code after switching the washing machine on. Otherwise the washing machine cannot be operated.

To activate the lock code

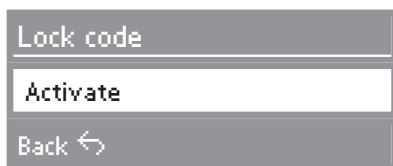

- Press the **OK** button.

The display will now request that a code is entered. The code is **125** and cannot be altered.

To enter the lock code



- Use the \wedge or \vee button to enter the first number. Confirm your selection of this number by pressing the **OK** button. Now enter the second number.
- Repeat the process until all three numbers have been entered and confirm your entry of the last number by pressing the **OK** button.

The following will appear in the display:



Once the washing machine is switched off, it can only be used again if the lock code is entered.

To use the washing machine when the lock code is activated

When the washing machine is switched on again, the display will request the code.

- Enter code 125 as described above and confirm the entry.

The washing machine is now unlocked and ready for use.

To deactivate the lock code

Proceed as for activating the lock code.

Temperature unit

You can choose for the temperature to be displayed in °C/*Celsius* or °F/*Fahrenheit*.

The option which is currently set will have a tick ✓ beside it.

Buzzer

When the buzzer function has been activated, an audible tone sounds at the end of a programme or when Rinse hold is reached.

You can select one of two volumes or switch the buzzer off.

Off

(The machine is delivered with this option selected.)

The buzzer is switched off.

Normal

The buzzer sounds at the end of a programme or when Rinse hold is reached.

Loud

The buzzer sounds at maximum volume (*Loud*) at the end of a programme or when Rinse hold is reached.

The option which is currently set will have a tick ✓ beside it.

Keypad tone

An audible tone sounds each time a button is pressed.

The machine is delivered with the keypad tone switched off.

The option which is currently set will have a tick ✓ beside it.

Brightness

There are ten different display brightness settings.

The machine is delivered with the display brightness on setting 5.

The brightness will change as soon as a different setting is chosen.

Contrast

There are ten different display contrast settings.

The machine is delivered with the display contrast on setting 5.

The contrast will change as soon as a different setting is chosen.

Settings menu

Standby display

To save energy, the display goes out and the indicator light for the *Start/Stop* button starts flashing slowly.

The display will always go out,

- if a programme is not selected within 10 minutes of the washing machine being switched on.
- 10 minutes after the end of a programme.

Pressing one of the buttons switches the display back on again.

You can also choose whether you want the display to go out 10 minutes after a programme has started or to remain visible throughout the programme.

On

The standby function is activated. The display will go out 10 minutes after a programme has started.

Not in current prog.

(the machine is delivered with this option selected)

The standby function is deactivated. The display will remain visible during a programme.

Memory

If an extra option has been selected for a programme, or the recommended temperature or spin speed has been altered, the machine will store the changes in memory at the start of a programme.

When this programme is chosen again these settings will appear in the display.

The machine is delivered with the memory function deactivated.

Anti-crease

Anti-crease helps prevent creasing if laundry is not normally removed immediately after the end of a programme.

The drum will turn at intervals for up to 30 minutes after the programme has finished. The door can be opened and items removed at any time during the anti-crease phase.

On

(the machine is delivered with this option selected)

Anti-crease is activated.

Off

Anti-crease is deactivated.

Miele washing machines offer perfect care for your laundry and feature a wide range of special programmes designed to suit the fabric being washed. Miele have also developed a range of specialist CareCollection detergents and conditioning products to offer you a complete package for cleaning and caring for your laundry.

The Miele CareCollection detergents and conditioning products are listed below. You can order these and many other useful products via the internet at:



All the products can also be ordered via the Miele Customer Contact Centre (see back cover for contact details).

CareCollection

Miele specialist detergents

"Outdoor wear"

This specialist detergent will clean your water-repellent outerwear with care.

"Sportswear"

The Miele Sportswear detergent is designed to clean sportswear and remove odours whilst taking care of the special microfibres used in these garments.

"Down Items"

This special-purpose detergent contains a mild tenside and has been specially formulated to keep down-filled items supple and to give them bounce.

Miele proofing agent

This special finishing agent reproofs garments against wind and water and provides a dirt-repellent finish whilst retaining elasticity and breathability.

Optional accessories

"UltraWhite" detergent

This multi-purpose powder detergent has excellent stain removal properties and is suitable for white and light coloured laundry as well as heavily soiled coloured items.

"UltraColor" detergent for coloured garments

This liquid detergent is particularly suitable for cleaning coloured and dark garments. The special formulation offers effective stain removal, even at low temperatures, while helping to prevent colours fading.

Liquid detergent "For Delicates"

This liquid detergent is ideal for the gentle treatment of delicate fabrics, such as wool and silk. Its special formulation cleans effectively at temperatures as low as 20°C, while protecting the colour of your delicate garments.

Fabric conditioner

The Miele fabric conditioner will give your laundry a fresh, natural fragrance. It makes garments soft to handle and prevents static build-up during tumble drying.

United Kingdom

Miele Co. Ltd.
Fairacres, Marcham Road
Abingdon, Oxon, OX14 1TW
Tel: 0845 365 0555
Fax: 0845 365 0777
Customer Contact Centre Tel: 0845 365 6600
E-mail: info@miele.co.uk
Internet: www.miele.co.uk

Australia

Miele Australia Pty. Ltd.
ABN 96 005 635 398
1 Gilbert Park Drive, Knoxfield, VIC 3180
Tel: (03) 9764 7130, Fax: (03) 9764 7149
Internet: www.miele.com.au

China

Miele (Shanghai) Trading Ltd.
1-3 Floor, No. 82 Shi Men Yi Road
Jing' an District
200040 Shanghai, PRC
Tel: +86 21 6157 3500
Fax: +86 21 6157 3511
E-mail: mieleshanghai@cn.miele.com
Internet: www.miele.cn

Miele (Hong Kong) Limited

41/F - 4101, Manhattan Place
23 Wang Tai Road
Kowloon Bay
Hong Kong
Tel: (852) 2610 1331
Fax: (852) 2610 1013
Email: mielehk@miele.com.hk

India

Miele India Pvt. Ltd.
Ground Floor, Copia Corporate Suites
Plot No. 9, Jasola
New Delhi - 110025
Tel: 011-46 900 000, Fax: 011-46 900 001
E-mail: customercare@miele.in
Internet: www.miele.in

Manufacturer: Germany - Miele & Cie. KG
Carl-Miele-Straße 29, 33332 Gütersloh



Ireland

Miele Ireland Ltd.
2024 Bianconi Avenue
Citywest Business Campus, Dublin 24
Tel: (01) 461 07 10, Fax: (01) 461 07 97
E-Mail: info@miele.ie, Internet: www.miele.ie

New Zealand

Miele New Zealand Limited
Unit L, 10-20 Sylvia Park Road
Mt. Wellington, 1060, Auckland, NZ
Tel: 0800 264 353, Fax: 0800 463 453
Internet: www.miele.co.nz

Singapore

Miele Southeast Asia
Miele Pte. Ltd.
163 Penang Road
04 - 02/03 Winsland House II
Singapore 238463
Tel: +65 6735 1191, Fax: +65 6735 1161
E-Mail: infosea@miele.com.sg
Internet: www.miele.sg

South Africa

Miele (Pty) Ltd
63 Peter Place, Bryanston 2194
P.O. Box 69434, Bryanston 2021
Tel: +27 (0) 11 548-1900
Fax: +27 (0) 11 548-1935
E-mail: info@miele.co.za
Internet: www.miele.co.za

United Arab Emirates

Miele Appliances Ltd.
P.O. Box 11 47 82
Gold & Diamond Park
Sheikh Zayed Road
Building 6 / Offices Nos. 6-214 to 6-220
Dubai
Tel: +971-4-341 84 44
Fax: +971-4-341 88 52
E-Mail: info@miele.ae
Internet: www.miele.ae